

Installation instructions

Transport | Installation | Operation | Maintenance | Disposal



Dual COMPACT

Series: GADC

*These instructions are to be considered part of the unit.
Read and follow these instructions carefully before performing any work on the unit.
Always keep these instructions accessible in the immediate vicinity of the unit
for future reference.*

guntner.com/uk

About us

Product family and line:	Dual COMPACT
Version number:	8
Date of revision:	2026-03-16

Copyright © 2026 by Güntner GmbH & Co. KG, Fürstfeldbruck, Germany.

This publication is protected by copyright.

All rights reserved. No part of this documentation may be copied, reproduced or transmitted into a form suitable for electronic systems and distributed in any form, even in part, without the authorisation of Güntner GmbH & Co. KG.

Installation instructions

These instructions have been compiled in several languages.

The German version applies as the **original installation instructions**. All other language versions are **translations** of the **original installation instructions**.

© Güntner GmbH & Co. KG
Hans-Güntner-Str. 2 – 6
82256 FÜRSTENFELDBRUCK

Phone +49 8141 242 0
Internet: www.guntner.com

Contents

1	Key basic information.....	7
1.1	Importance of the instructions.....	7
1.2	Applicable documents.....	7
1.3	Responsibilities.....	7
1.3.1	Responsibilities of the manufacturer of the system.....	7
1.3.2	Responsibilities of the owner or operator.....	8
1.4	Definition of the target group and requirements.....	8
1.5	Legal note.....	11
1.6	Document conventions.....	12
1.7	List of abbreviations.....	12
1.8	Conventions for safety signs and instructions.....	13
1.8.1	General safety signs and their meaning in these instructions.....	13
1.8.2	Warning signs and their meaning in these instructions.....	13
1.8.3	Prohibitory signs and their meaning in these instructions.....	14
1.8.4	Mandatory signs and their meaning in these instructions.....	15
2	Description.....	16
2.1	Types of Dual COMPACT.....	16
2.1.1	Technical data of the unit.....	18
2.1.2	Technical data of the fans.....	18
2.2	General information.....	19
2.3	Design and function.....	20
2.3.1	Versions.....	20
2.3.2	Operating modes.....	22
2.4	Fan motor.....	23
3	Safety.....	25
3.1	Intended/improper use.....	25
3.1.1	Intended use.....	25
3.1.2	Operating conditions.....	25
3.1.3	Improper use.....	25
3.2	Labelling on the packaging/the unit.....	27
3.2.1	Packaging overview.....	27
3.2.2	Signs and notes on the packaging.....	27
3.2.3	Unit overview.....	28
3.2.4	Safety signs on the unit.....	29
3.2.5	Other signs and notes on the unit.....	31
3.3	Basic safety instructions.....	31

3.3.1	Please note.....	31
3.3.2	Electrical hazard.....	32
3.3.3	Hazard due to working fluids.....	32
3.3.4	Hazard due to vibrations.....	34
3.3.5	Hazard due to pressurised parts.....	35
3.3.6	Thermal hazard.....	35
3.3.7	Mechanical hazard.....	36
3.3.8	Hazard due to fans.....	37
3.3.9	Other hazards.....	37
3.3.10	Hazards due to accessories.....	38
4	Transport and unpacking.....	39
4.1	Safety instructions for transport and unpacking.....	39
4.2	Transport and storage of the unit.....	40
4.2.1	Transporting the unit.....	40
4.2.2	Storing the unit prior to installation.....	41
4.3	Unpacking the unit.....	41
4.4	Checking the transport pressure.....	42
5	Installation and commissioning.....	45
5.1	Safety instructions for installation and commissioning.....	45
5.2	Requirements for the place of installation.....	46
5.3	Installation of the unit.....	48
5.3.1	Installing the unit.....	48
5.4	Connecting the unit.....	52
5.4.1	Connecting the unit to the plant.....	52
5.4.2	Connecting the drain line to the tray.....	55
5.5	Electrically connecting and protecting the unit.....	56
5.6	Connection diagrams.....	57
5.7	Performing an acceptance test.....	57
6	Operation.....	60
6.1	Safety instructions for operation.....	60
6.2	Putting the unit into operation.....	61
6.3	Taking the unit out of operation.....	62
6.4	Shutting down the unit.....	62
6.5	Putting the unit back into operation after shutdown.....	63
6.6	Defrosting.....	63
6.6.1	Defrosting functions.....	63
6.6.2	Defrosting the unit.....	65
6.6.3	Factors influencing the defrosting process.....	66
6.6.4	Defrost control.....	66
6.7	Changeover to a different working fluid.....	69

	6.8	Troubleshooting.....	69
7		Maintenance and cleaning.....	72
	7.1	Safety instructions for maintenance and cleaning.....	72
	7.2	Procedure prior to all maintenance work.....	74
	7.3	Inspection/maintenance schedule.....	74
	7.3.1	Unit.....	74
	7.3.2	Heat exchanger coil.....	75
	7.3.3	Fans.....	76
	7.4	Maintenance work.....	77
	7.4.1	Fixing leaks.....	77
	7.4.2	Cleaning the unit.....	77
	7.4.3	Remove/hinge down the tray and side cover.....	78
	7.4.4	Cleaning the coil.....	78
	7.4.5	Cleaning the fans.....	80
	7.5	Procedure after all maintenance work.....	80
8		Dismantling and disposal.....	82
	8.1	Safety instructions on dismantling and disposal.....	82
	8.2	Dismantling the unit.....	83
	8.3	Disposing of the unit.....	83
9		Accessories.....	84
	9.1	Condensate pump.....	84

Version history

The following table lists the respective changes compared to the old versions.

Attention! Minor changes to the instructions, such as the wording of the text or the layout, are not listed separately.

Version of the instructions	Changes/additions
6	Version of the instructions after which the version history was introduced
7	The following changes have been made to these instructions: <ul style="list-style-type: none"><li data-bbox="552 775 1158 808">• Revision of the structure and outline of the manual<li data-bbox="552 808 1331 840">• Update of the standards for fans, additional text regarding EC fans

1 Key basic information

1.1 Importance of the instructions

These instructions apply for the units of the Dual COMPACT product family and line. The Dual COMPACT is a dual discharge unit for heat extraction for indoor installation with variable equipment for many applications of Commercial Refrigeration. The Dual COMPACT offers the possibility of operation with various working fluids and different operating principles (e.g. water/glycol: air cooler; CO₂: evaporator). In addition, a variety of casings, variable equipment options and adjusted fan concepts are available.

Legal framework

These instructions have been written for the European Union.

The following directives and standards apply under EU law:

- Machinery Directive 2006/42/EC
- Pressure Equipment Directive 2014/68/EU ¹⁾
- EMC Directive 2014/30/EU

¹⁾ Not all products fall within the scope of this Directive

1.2 Applicable documents

The following documents are applicable:

- These instructions
- Documentation on selected accessories, if any
- Connection diagram (enclosed with the terminal box)
- For further technical data, see nameplate

These instructions are part of the system's operating instructions, which are provided by the system's manufacturer.

1.3 Responsibilities

1.3.1 Responsibilities of the manufacturer of the system

The responsibilities of the manufacturer of the system are reflected in the unit's construction in acc. with EN 378-2 (design, manufacture and testing).

The manufacturer of the system has the following obligations:

- Planning, design and calculation of the system in acc. with the statutory provisions, possibly also by an external planning consultancy (for required qualifications, see "Definition of the target group and requirements").
- Creation of the technical documentation and the system's operating instructions.
- Performing the conformity assessment procedure(s) and creation of the declaration(s) of conformity.

- Planning and preparing emergency measures:
To avoid consequential damage caused by malfunction, a warning system that immediately signals all faults must be provided on site. Prepare emergency measures that prevent consequential damage to persons, property and the environment should faults occur.
- Specify checking and maintenance intervals:
The system must be designed and equipped with all required equipment for maintenance, servicing and testing in acc. with EN 378-4.
- Point out the need for sufficient instruction of the operating and monitoring personnel for the operation and maintenance of the system.
- Inform Güntner GmbH & Co. KG (component supplier) immediately if faults occur during the installation, startup and operation:
claims@guentner.com

When the unit is integrated into the refrigeration system, the working fluid and unit type must not deviate from the order-related information specified in the order documents.

It is recommended that the future customer staff – if possible – is present on site during the installation, for tightness tests and cleaning, while the system is being filled with working fluid and for the adjustment of the system.

The accident prevention rules and regulations that apply for the place of installation must also be observed.

1.3.2 Responsibilities of the owner or operator

The responsibilities of the owner or operator are reflected in the operation, maintenance, repair and recovery of the system in acc. with EN 378-4.

The owner or operator must ensure that the employees entrusted with the operation, monitoring and maintenance of the system are adequately instructed and competent.

The operating personnel responsible for the system must have sufficient knowledge and experience with regard to the operating principles, operation and daily monitoring of this system.

Before commissioning the system, the owner or operator must ensure that the operating personnel are sufficiently instructed about the system's documentation (which is part of these instructions) on the set-up, monitoring, operating principles and maintenance of the system and the safety measures to be observed, and with regard to the properties and handling of the working fluid to be used.

The owner or operator must ensure that when operating, monitoring and maintaining the system, the working fluid and unit type do not deviate from the information specified in the order documents.

Planning and preparing emergency measures: To avoid consequential damage caused by malfunction, a warning system that immediately signals all faults must be provided on site. Prepare emergency measures that prevent consequential damage to persons, property and the environment should faults occur.

Responsibility remains with the owner or operator of the system if the system is used by anybody else unless there is an agreement on a different division of responsibilities.

1.4 Definition of the target group and requirements

General

Only persons who meet the requirements for the personnel may work in the area of the unit. This group of persons is defined below. To prevent damage to health and property, the operator must take measures to prevent unauthorised persons from gaining access to the unit.

Persons who are responsible for working on this unit in the various phases of its life cycle must have the necessary qualifications and competence for the respective tasks in acc. with the applicable local regulations.

Definition of the group of persons

Person	Qualification
Consultant for technical building equipment (TBE)	Master's or Bachelor's degree, or similar educational background, in the field of plant construction, supply engineering or refrigeration and air conditioning
Lorry driver	Valid LGV licence, additional training for heavy loads if necessary
Crane/forklift operator	Valid driving licence for crane/forklift truck
Warehouse worker	Specialised training as a warehouse worker or at least sufficient in-house qualification
Skilled electrician	Qualified training to become a (skilled) electrician
Fitter/welder	Qualified training for the installation and welding of pipes and the installation of cooling circuits and refrigeration plants
Skilled welder	Qualified training to become a welder for coolant and refrigerant pipes that are subject to approval due to their classification in acc. with the Pressure Equipment Directive
Refrigeration technician	Training to become a recognised mechatronics technician for refrigeration and air conditioning technology (master craftsman), or refrigeration engineer (Bachelor's degree). If necessary, additional training for handling flammable or toxic refrigerants such as propane or NH ₃
Mechanic	Training to become an industrial mechanic or comparable specialised training
Operator	Is able to monitor the safe operation of the system
Cleaning professional	Instruction in the use of cleaning methods and suitable cleaning agents

Definition of tasks for the respective life cycle phases

Life cycle phase	Task	Group of persons
Transport and storage	Transporting to the storage location or place of installation	Lorry driver
	Loading/unloading	Crane/forklift operator, warehouse worker
	Performing incoming goods inspection	Warehouse worker
	Performing intermediate storage	Crane/forklift operator, warehouse worker
Unpacking	Unpacking	Mechanic, warehouse worker
	Checking the transport pressure	Fitter/welder, refrigeration technician
	Performing maintenance runs of fans	Skilled electrician
	Disposing of packaging material	Warehouse worker
Mounting/installation	Loading/unloading at the place of installation	Crane/forklift operator
	Mounting/installing and removing	Fitter/welder, refrigeration technician, mechanic
Connection	Connecting electrical components	Skilled electrician, refrigeration technician
	Connecting hydraulic/refrigeration components	Fitter/welder, refrigeration technician
	Welding/brazing refrigerant pipes	Skilled welder
	Flushing the pipes	Fitter/welder, refrigeration technician
	Performing acceptance tests	Fitter/welder, refrigeration technician
Commissioning	Filling with working fluid	Fitter/welder, refrigeration technician
	Performing the commissioning and settings	Fitter/welder, refrigeration technician
Operation	Performing functional checks	Operator
	Switching on/off	Operator
	Monitoring the cooling operation	Fitter/welder, refrigeration technician, operator
	Checking for damage	Skilled electrician, fitter/welder, refrigeration technician, operator
Troubleshooting	Performing a visual inspection	Skilled electrician, fitter/welder, refrigeration technician, mechanic, operator, cleaning professional
	Performing refrigeration tests	Refrigeration technician
	Performing electrical tests	Skilled electrician, refrigeration technician

Life cycle phase	Task	Group of persons
Maintenance/repair	Performing a visual inspection	Operator
	Replacing wear parts	Skilled electrician, fitter/welder, refrigeration technician, mechanic
	Performing weekly maintenance	Operator
	Performing annual maintenance	Skilled electrician, fitter/welder, refrigeration technician, mechanic
	Replacing fans	Skilled electrician, refrigeration technician, mechanic
	Replacing the control system	Skilled electrician, refrigeration technician
	Fixing leaks	Fitter/welder, refrigeration technician, skilled welder
	Performing cleaning tasks	Fitter/welder, refrigeration technician, cleaning professional
Shutdown and taking out of operation	Taking out of operation	Fitter/welder, refrigeration technician
	Shutting down	Fitter/welder, refrigeration technician
	Draining/removing by suction (refrigerant)	Refrigeration technician
	Draining (water)	Fitter/welder
Removal	Disconnecting the lines	Skilled electrician, refrigeration technician
	Disassembling/dismantling/removing	Fitter/welder, refrigeration technician, mechanic
Disposal	Disposing of materials	Crane/forklift operator and lorry driver, refrigeration technician, operator

1.5 Legal note

Note that warranty claims require the existence of a defect that must be proved. These installation instructions are part of the unit and must be observed in their entirety. Damage and malfunctions resulting from the failure to comply with the installation instructions are not covered by the warranty. This applies in particular to the use of spare parts other than those specified (original spare parts in case of doubt) and modifications to the unit compared to its original condition on delivery without the consent of Güntner GmbH & Co. KG. Modifications in this sense are, in particular, the use of working fluids other than those specified, changes to the operating parameters and mechanical changes such as metal-cutting operations (e.g. drilling) without sufficient protection of the unit against chips.

1.6 Document conventions

Mark-up elements for special information

bold	Requires special attention!
⇒ –	Instructions Instructions (sub-item)
• ◦	Listing Listing (sub-item)



1.7 List of abbreviations

Abbreviation	Meaning
°C	Degrees Celsius (Celsius scale temperature)
1~	Single-phase alternating current
3~	Three-phase current
bar	Bar (pressure indication)
BImSchV	German Federal Emission Control Regulation
CO ₂	Carbon dioxide working fluid
D	Delta connection (electrical connection type with three-phase motors)
PED	Pressure Equipment Directive
DX	Direct expansion
EN	European standard
EN 378	European standard 378: Refrigeration systems and heat pumps; safety-related and environmental requirements
HFC/FC	(Hydro)fluorocarbons working fluid
Hz	Hertz (frequency)
IP	Degree of protection against the penetration of solids/liquids
ISO	International Organization for Standardization (German: Internationale Organisation für Normung)
l	Litre (volume)
mm	Millimetre
Emergency STOP	Switch for immediately switching off the refrigeration system
P	Pump (forced circulation)
PPE	Personal protective equipment
S	Star connection (electrical connection type with three-phase motors)

VDE	“Verband der Elektrotechnik Elektronik Informationstechnik e. V.” (Association for Electrical, Electronic and Information Technologies)
-----	---

1.8 Conventions for safety signs and instructions

1.8.1 General safety signs and their meaning in these instructions

⚠ DANGER	
	This signal word is used to show an immediately dangerous situation which, if not avoided, will cause severe injury or death.
⚠ WARNING	
	This signal word is used to show a potentially dangerous situation which, if not avoided, could cause severe injury or death.
⚠ CAUTION	
	This signal word is used to show a potentially dangerous situation which, if not avoided, could cause minor or moderate injury.
ATTENTION	
	This signal word without any safety symbols is used to show a possible risk of damage to property.
NOTICE	
	This signal word indicates additional information that is useful for the reader, such as operator tips and cross references.

1.8.2 Warning signs and their meaning in these instructions



Warning of hand injury
Failure to observe the warnings can result in hands or fingers being crushed, drawn in or otherwise injured.



Warning of hot surface
The temperature is above +45 °C (the temperature at which protein clots) and can cause burns.



Warning of extreme cold
The temperature is below 0 °C and can cause frostbite.



Warning of dangerous electrical voltage
Risk of an electric shock if live parts are touched.



Warning of heavy loads
Severe injuries can occur when lifting.



Warning of the risk of cutting
Sharp edges and corners.



Warning of risk of crushing
Transport, loading and unloading can result in life-threatening injury.



Warning of the the risk of slipping
After defrosting, after cleaning work or due to other circumstances, there is a risk of slipping.



Warning of explosive substances at the place of installation
Use of ignition sources can cause explosions at the place of installation.



Warning of flammable substances at the place of installation
Use of ignition sources can cause fire at the place of installation.



Warning of toxic substances at the place of installation
Contact with or inhaling toxic substances can cause injury or death.



Warning of suspended loads
Standing under suspended loads can cause injury or death.



Warning of risk of suffocation
Being in an atmosphere with oxygen deficiency or with hazardous substances, gases or vapours can cause suffocation and death.



Warning of falling objects
Standing under falling objects can cause injury or death.



Warning of swivelling parts of the unit
Standing within the swivel range of the unit can cause injury or death.



Warning of high operating pressure
Breakage of pressurised components can cause injury or death.



Warning about general risks
General hazards to persons can cause injury or death.



Warning of automatic start-up
Automatic start-up of fans can result in hands and fingers being trapped.



Warning of the danger of pulling in
If body parts are being pulled into the unit, this can cause injury or death.

1.8.3 Prohibitory signs and their meaning in these instructions



No fire, no naked flames and no smoking!

Ignition sources must be kept away or at a safe distance, and ignition sources must not develop.

1.8.4 Mandatory signs and their meaning in these instructions



Use hearing protection!
Hearing protection must protect against loud noises.



Wear protective clothing!
Personal protective clothing must be suitable for the working fluid used and for low temperatures respectively, and must have good heat insulation properties.



Completely disconnect before working!
Completely disconnect the electrical system and secure it against restart before performing installation, maintenance and repair work.



Use eye protection!
Eye protection must protect against mechanical and chemical dangers and radiation.



Wear protective headgear!
Head protection must protect against hazards caused by impact with objects, swinging objects, falling objects or ejected objects.



Wear safety shoes!
Safety shoes must protect against external, damaging influences and offer protection against slipping.



Wear protective gloves!
Protective gloves must protect against mechanical and chemical dangers.



Lifting point/lifting hook
Marking of lifting points to ensure safe transport of loads.



Use respiratory protection!
Breathing apparatuses must be suitable for the working fluid used. Breathing apparatuses must consist of:

- At least two self-contained breathing apparatuses (respiratory protective devices)
- For ammonia: an additional breathing apparatus with filter (full mask) or a self-contained breathing apparatus (respiratory protective device)

2 Description

2.1 Types of Dual COMPACT

Introduction

Güntner's Dual COMPACT GADC is a unit with variable equipment. Depending on the requirements, it can be configured in the most diverse variants. The following tables show the individual configuration options available for Güntner units.

Refer to the order documents for the exact unit name.

Letter (example)	Meaning	Possible variants
G	Company	G: G üntner
A	Function	A: A ir cooler (air cooler/evaporator)
C	Design	C: C ubic S: S lim D: D ual M: M ini I: I nsulated F: F loor
V	Product line	C: C OMPACT V: V ARIO P: P rocess [APPLICATION] A: A gri [APPLICATION] B: B last [APPLICATION]
A	Fluid	A: A mmonia R: R efrigerants (A1 refrigerants) C: C O ₂ P: P otentially dangerous (refrigerants of class A2L and higher) F: F luids in general W: W ater (water operation only)
P	Operating mode	P: P ump X: Direct eX pansion G: G ravity

Exemplary presentation of the nomenclature

NOTICE

If not marked separately, all information in the following sections refer to the standard unit!

Fans

Number of fans	Fan diameters
1 - 4	350 mm

Available working fluids and their operating modes

Working fluid	Operating mode
FCs/HFCs of class A1	DX (direct expansion)
Carbon dioxide (CO ₂)	DX
Refrigerants of classes A2L to A3	DX
Coolants (e.g. water/glycol)	P (pump)

Available defrost types

	Circulating air	Electric
Coil and tray	X	X

Material combinations available as a standard

Material	Core tube	Fin	Casing	Tray
AlMg			X	X
Aluminium		X		
Copper	X			
Stainless steel			(X)	(X)
Aluminium, epoxy resin-coated		(X)		
Coil Defender*	(X)	(X)		

X Standard design
 (X) Option
 * entire coil is coated

Time limits

Service life: 6 – 8 years

Accessories available as a standard

- Condensate pump
- Electric defrost heater

2.1.1 Technical data of the unit

NOTICE				
The specified typical values refer to standard types of this series. The following applies to special units in particular: Observe the specifications in the design (appendix) and on the nameplate.				

Series and suffix	GADC CX	GADC RX	GADC FP, GADC WP	GADC PX
Project number	See nameplate			
Unit name	See nameplate			
Serial number	See nameplate			
Year of manufacture	See nameplate			
Working fluid	CO ₂	FCs/HFCs of class A1	Water/glycol; water	Refrigerants of classes A2L to A3
Volume	See nameplate			
Max. permissible pressure (PS)	80 bar	32 bar	10 bar	32 bar
Test pressure	114.4 bar	35.2 bar	11 bar	35.2 bar
Permissible operating temperature (working fluid temperature)	-33/+100 °C	-33/+100 °C	-33/+100 °C	-33/+100 °C
Permissible ambient temperature	-25/+45 °C	-25/+45 °C	-25/+45 °C	-25/+45 °C
Permissible humidity	0 – 100 %	0 – 100 %	0 – 100 %	0 – 100 %
Airborne noise emitted	See order documents			
Weight	See order documents			

2.1.2 Technical data of the fans

NOTICE	
The capacity values of the fans depend on the ambient temperature and the air resistance at the place of installation. All electrical parts are designed in acc. with EN standards. The technical delivery conditions are in acc. with DIN 24166, accuracy class 2. For more information on the voltage and the type of current for the respective unit, please refer to the order documents.	

Fan type	See order documents
----------	---------------------

Degree of protection	At least IP44, ISO F and DIN EN 60034-1
Type of current	1~ alternating current
Voltage	1~230 V, 50/60 Hz
Balancing quality	Q 6.3 in acc. with DIN ISO 21940-11
Permissible ambient temperature	-25 to +45 °C
Protective devices	<ul style="list-style-type: none"> • Temperature monitor (TM) wired internally

2.2 General information

Introduction

Units of the Dual COMPACT product family are intended for installation in a refrigerating plant and in the heat carrier circuit of a cooling plant respectively. The refrigerating plant/cooling plant is a combination of interconnected refrigerant-carrying components and fittings that form a closed circuit in which the working fluid circulates.

Overview

The design and function are shown using the example of a Dual COMPACT GADC standard unit.

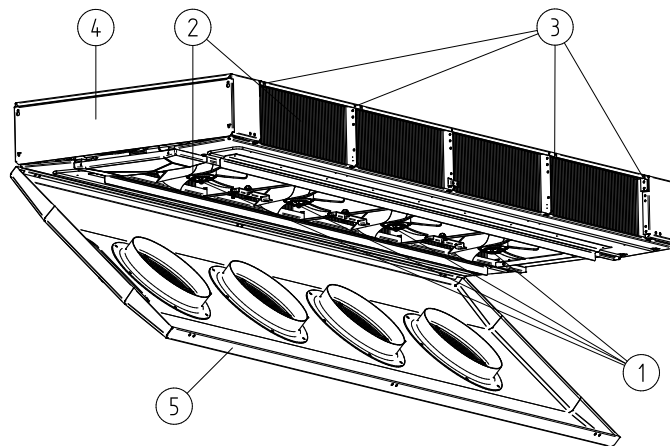

Function

No.	Designation	Function
1	Fan	Sucks the ambient air into the casing. The air flows into the room again via the heat exchanger
2	Fins	Take up the heat of the working fluid from the ambient air
3	Fixing points	For fixing the unit to the ceiling
4	Removable side panel (on both sides)	Access to the connections, fittings and terminal box

No.	Designation	Function
5	Tray with condensate drain can be hinged down on both sides	Holds the fans; is insulated in such a way that no drops form under the cooler. The condensate drain drains the condensate and the condensation water. If the unit is designed with the optional condensate pump, there is no condensate drain.

2.3 Design and function

2.3.1 Versions

Overview

The unit is available with up to four fans in the following versions:

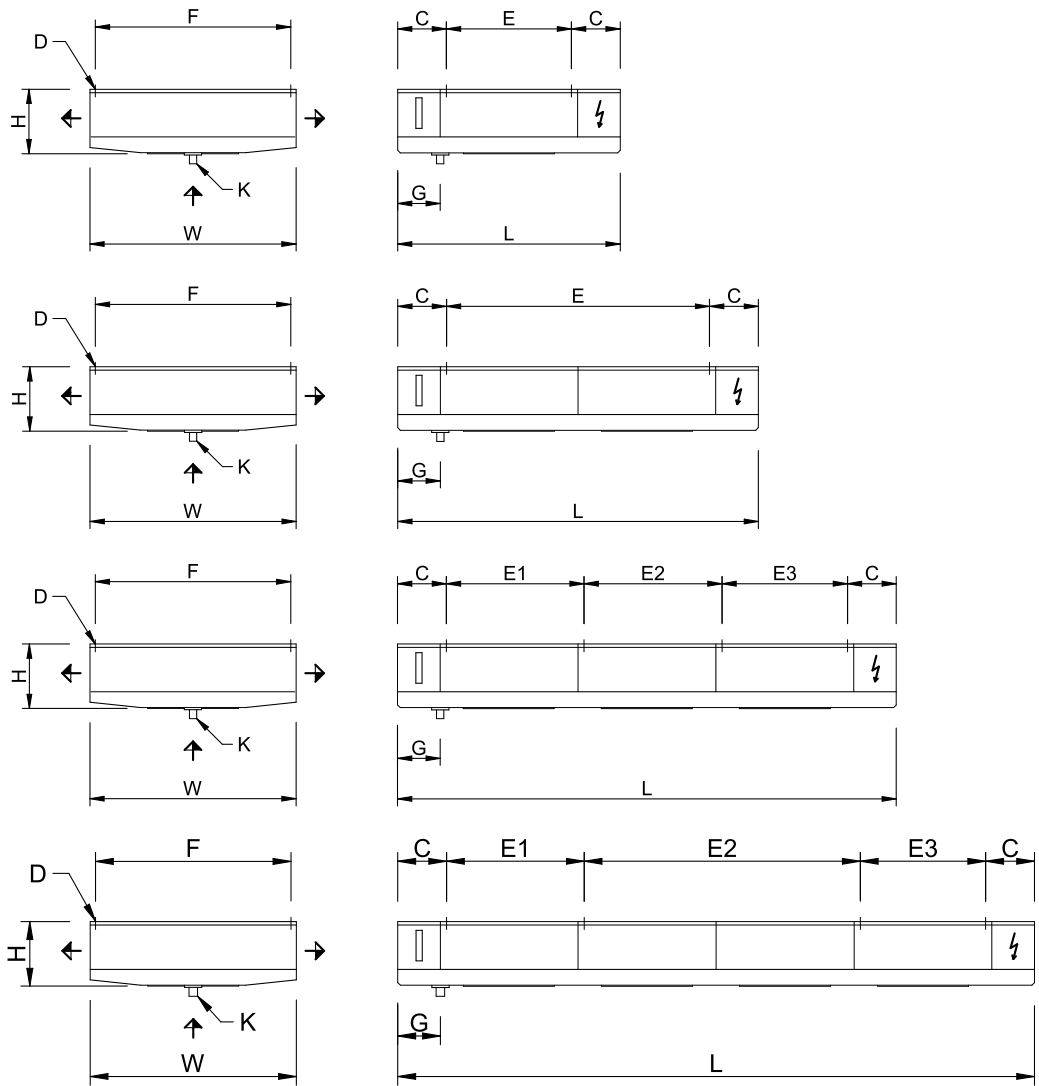

- C Outer edge of unit to first bracket for ceiling mounting (240 mm)
- D Diameter of screw hole in side plate (Ø 11 mm)
- E Distance between the brackets for ceiling mounting
- E1 Fixed measure 678 mm
- E2 $L - (2 \times C + E1 + E3)$
- E3 Fixed measure 618 mm
- F Fixed measure 963 mm
- G Distance end of casing to centre of condensation drain

- H Casing height
- K Diameter of the drain
- L Casing length
- W Casing width

Refer to the order documents for the dimensioning of the units for the available sizes.

2.3.2 Operating modes

Introduction

The unit can be operated in different ways:

- Direct expansion (**DX**)
- Pump (**P**) using brine

Direct expansion (DX)

Inlets and outlets

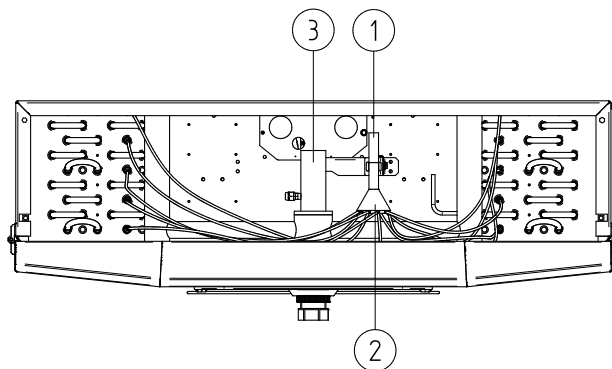

No.	Designation
1	Inlet of refrigerant via expansion valve (throttle valve)
2	Distributor
3	Outlet of refrigerant

Operating principle

The liquid working fluid enters the evaporator (1) via the expansion valve at low temperature and low pressure and is evenly distributed in the piping system through a distributor (2). In the piping system, the working fluid absorbs heat from the ambient air over the entire heat exchanger surface and evaporates. The compressor sucks in the gaseous working fluid and the working fluid leaves the evaporator via the outlet (3). The working fluid is compressed under high pressure in the compressor, thus raising the temperature level. The working fluid is liquefied again in the condenser. During this process, it releases the absorbed evaporation and compressor heat again. The expansion valve expands the working fluid, and the cycle starts again from the beginning.

Pump (P) (forced circulation)

Inlets and outlets

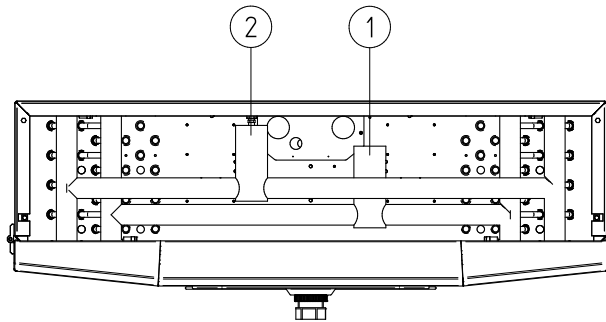

No.	Designation
1	Inlet of cold brine
2	Outlet of cold brine

Operating principle using brine

The liquid working fluid absorbs heat as it passes through the air cooler without changing its state of matter. It leaves the unit as liquid working fluid.

2.4 Fan motor

Safety

NOTICE

Operate the unit once a month at full speed for at least three hours so that the bearings move and any penetrated condensate can evaporate.

NOTICE

With fans with an IP55 rating or higher, open the existing closed condensation water holes at least once a month.

⚠ CAUTION



RISK OF INJURY!

Operating the fan at wrong speeds may result in unexpected oscillations, vibrations and resonances. Parts of the fan can break, which can injure bystanders.

- Connect the fans in the terminal box in acc. with the motor connection wiring diagram and check for proper connection.
- Perform acceptance test of the fans.
- Check the fan unit regularly in acc. with the inspection and maintenance schedule.

AC technology

The AC motors are usually protected from superheating by a thermal contact (or PTC resistor).

With motors with thermal contact, wire the thermal contact in such a way that the motor cannot be started when the thermal contact is triggered. A locking device is recommended to prevent unintentional restart.

Motors with PTC resistor require an additional external trigger unit for the built-in thermistors. A locking device is recommended to prevent unintentional restart. The test voltage at the thermistors must not exceed 2.5 V or only current-limited measuring equipment may be used.

When using a star-delta connection, a corresponding time delay must be taken into account.

For motors with direct start and a connected load > 4.0 kW, a starting current limitation (soft start by means of thyristor) may be required.

If frequency converters are to be used for speed control, note the following regarding external rotor fans:

All-pole sinusoidal filters must be installed between the frequency converter and the fans (sinusoidal output voltage! Filter effect between phase to phase and phase to earth).

The frequency converters of the Güntner company are equipped with this function as a standard. Three-phase standard motors are suitable for direct operation with frequency converters.

Three-phase fan motors can be operated by means of star-delta connection or with speed control. Check the direction of rotation. A change in the direction of rotation in the event of an incorrect direction of rotation is achieved by swapping two phases.

EC technology

Please inform yourself about general differences between EC and AC technology.

The EC fans can be operated either at a fixed fan speed or via analogue 0 – 10 V signal. For the 0 – 10 V control, all (1 – 4) EC fans are grouped on site and wired to terminal box with printed circuit board. For operation, a supply line for the power supply must be laid on site. The intended speed is clearly linked to the type designation and already set accordingly via jumpers in the terminal box. Refer to the order documents for the exact value.

3 Safety

3.1 Intended/improper use

3.1.1 Intended use

Güntner Dual COMPACT units are intended for installation in a refrigerating plant used for cooling and circulating the room air, in commercial applications such as processing rooms, picking areas, corridors, showrooms or rooms with temperature 0 °C.

The operator of the system determines the operating point.

The nameplate indicates the state of matter of the fluid (liquid/gaseous), the fluid group (hazardous/non-hazardous), the permissible pressure and the temperature.

The machine must be operated in the professional sector.

3.1.2 Operating conditions

Safety measures

Observe the following to avoid personal injury, environmental damage and damage to property in acc. with the state of the art:

- The unit must be used only in acc. with the proper intended use.
- Maintain and clean the unit regularly (see section "Maintenance and cleaning").
- Ensure that the working fluid and unit type do not deviate from the information specified in the order documents when operating, monitoring and maintaining the system.
- Ensure that maintenance measures are performed in compliance with the system's operating instructions.
- Operate the unit only with the working fluids indicated on the nameplate (fluid group and state). Filling the unit with a different fluid is permitted only with the prior written consent of the manufacturer.
- Certain working fluids may be used only in conjunction with specific materials. Pay attention to the exact unit name in chapter "Types of Dual COMPACT".
- The maximum permissible operating pressure stated on the nameplate must NOT be exceeded.

3.1.3 Improper use

General

The unit is being used improperly if:

- an unspecified working fluid, an unspecified pressure, an unspecified temperature and/or an unspecified connecting piping not prescribed in acc. with the instructions are used,
- the unit is not completely disconnected for cleaning/maintenance purposes,
- the main dimensions, weight, distances and recommended fixing sizes are not taken into account/adhered to during mounting,
- the supply line (electric) is fused or dimensioned incorrectly on site,
- the wrong fixing elements or not all of the fixing points provided were used for mounting,
- swarf falls into the pipe (when cutting off the connection piece without using a pipe cutter),

- the unit is defrosted improperly, which leads to severe icing on core tubes, fins and in the connection compartment, which in turn can lead to cracks and fractures in refrigerating system components,
- the unit is operated in an environment or for capacity requirements (e.g. aggressive/corrosive environment; capacity range) the unit with its material combination or capacity is not designed for, or which do not correspond to the intended use.

Improper modifications

The unit must not be modified without prior written consent of Güntner GmbH & Co. KG. Modifications to the unit are:

- Change of the operating point (the specified operating point is indicated in the order-related documents)
- Changing the fan capacity (air volume)
- Changing the volume of the working fluid passing through
- Changeover to a different working fluid
- Changeover of the originally designed defrost technology
- Modification to load-bearing components or the casing (remodelling/changes)

Improper operation

The unit must not be operated if it is damaged or shows signs of faults. All damage and faults must be reported to Güntner GmbH & Co. KG immediately and must be rectified without delay.

3.2 Labelling on the packaging/the unit

3.2.1 Packaging overview

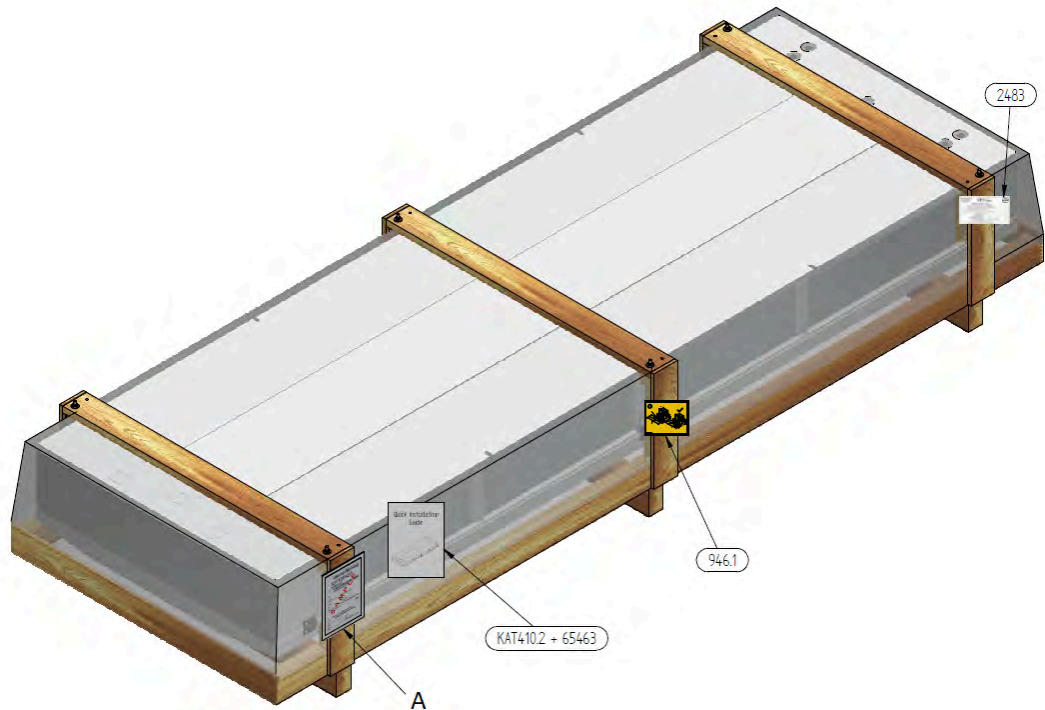



Wooden packaging

A – Intralogistics label

3.2.2 Signs and notes on the packaging

Güntner GmbH & Co. KG
Hans-Güntner-Straße 2 - 6
82256 Fürstenfeldbruck
www.guentner.de

 0036 PED *

 0168 PE(S)R *





Projektnummer - Project number	101164186	
Gerätebezeichnung - Unit name	S-AGHN 080.2H/210-HND/12P.E	
Gerät Seriennummer - Unit serial number	405167157/43.01256	
Ventilator/ID/Drehzahl/Stromaufn. - Fan/ID/Speed/Current	VT03059U.2 / 3241 / 865 min -1 / 2,1 A	
Umgebungstemperatur - Ambient air temperature	-30 °C / +50 °C	
Herstellungsjahr - Year of manufacture	2022	
* Druckgerät Seriennr. - Pressure equipment serial no.	405167182/43.01264	
Volumen - Volume (V)	108.9 l	
Max. zulässiger Druck (PS) Max. permissible pressure (PS)	32 / 0 bar	0 / -1 bar
Zulässige min./max. Temperatur (TS) Permissible min./max. temperature (TS)	-50 °C / +150 °C	-50 °C / +40 °C
Prüfdruck(PT)/Prüfmedium - Test pressure(PT)/Test medium	35.2 bar / Druckluft - Compressed air	
Prüfdatum - Test date	20.01.2022	
Fluidgruppe / Zustand - Group of fluid / State	1 / gasförmig - gaseous	

2483 – Nameplate – **exemplary illustration**



65463 – Shipping documents pocket

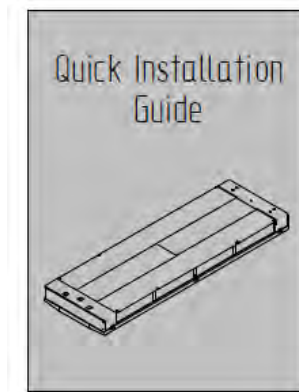

KAT410.2 – Quick Installation Guide

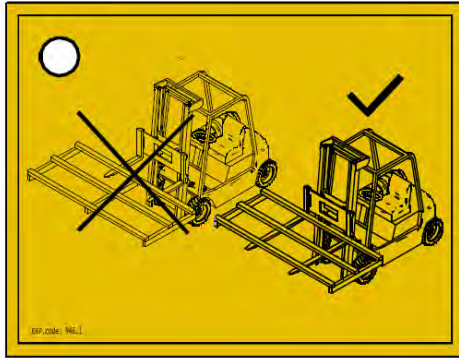

946.1 – Transport by industrial truck with forks

3.2.3 Unit overview

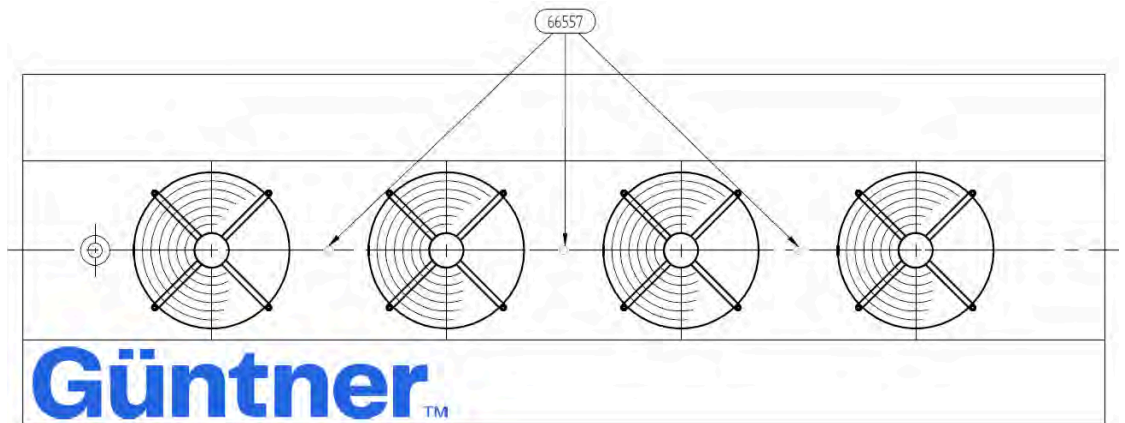

Bottom view

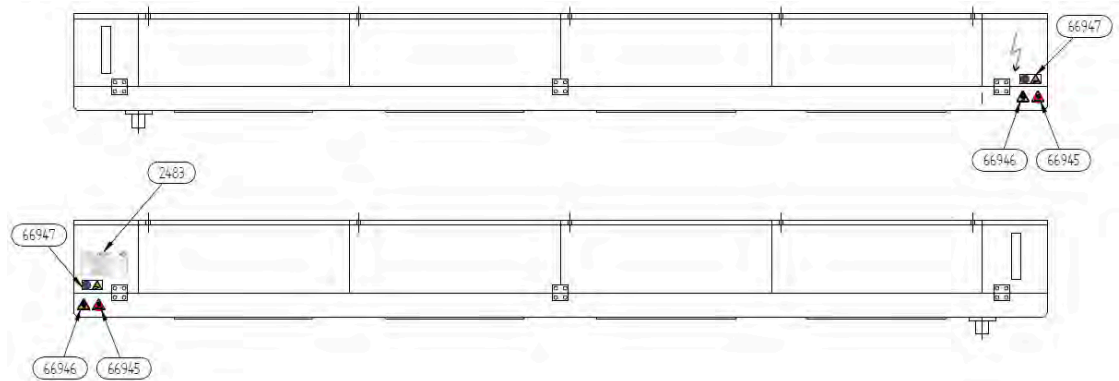

Rear view

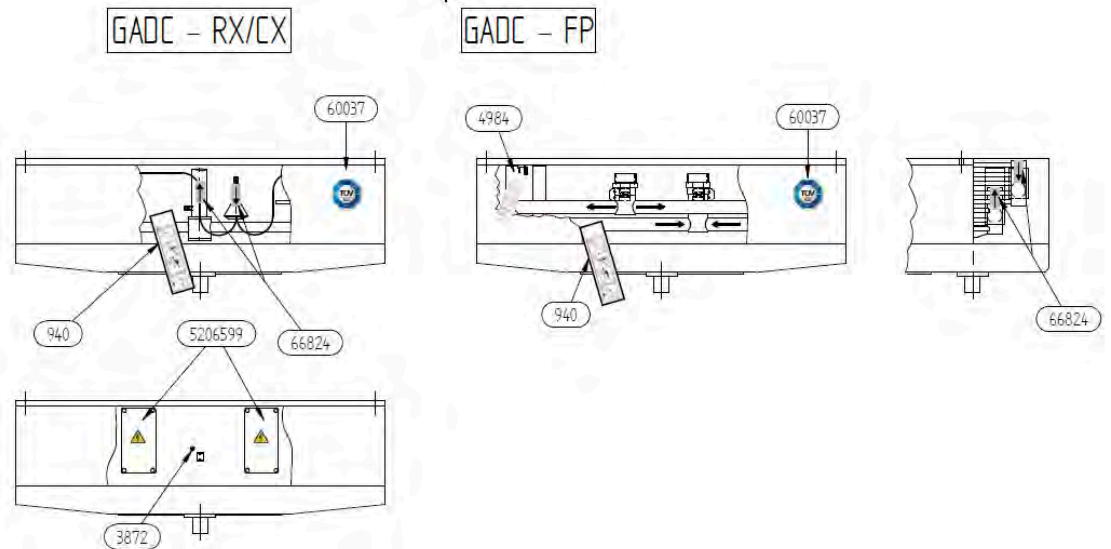

Side views for HFC and CO₂ (on the left) and for glycol respectively (on the right)

3.2.4 Safety signs on the unit

Specific safety signs on the unit:

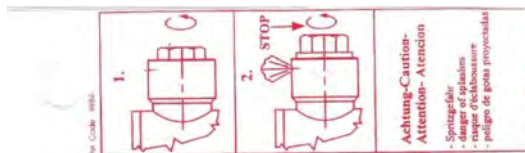

4984 – Warning “Risk of splashes” (with water/glycol working fluid)

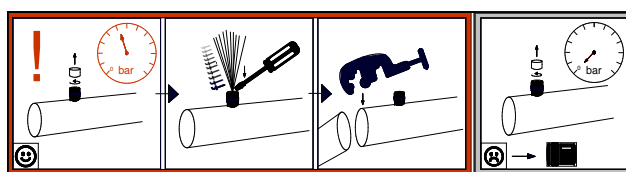

940 – Transport filling at Schrader valve



66947 – Inspection cover/inspection door:
“Disconnect completely before working”,
“Warning of risk of crushing”



66946 – Warning “Falling objects”



5206599 – Warning of electric shock (always with electrical parts)



66945 – Warning “Do not stand within the units' swivel ranges”

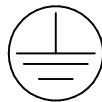

3872 – Earthing marking. The earthing marking in the drawing (connection side of the unit and the side of the unit where the terminal box is located respectively) shows the earthing point for earthing connection on site. The earthing connections on the unit itself are also marked with this label (not shown in the drawing).



66557 – Points to be pressed for the SnapLoc fastener to lock into place

3.2.5 Other signs and notes on the unit

Güntner GmbH & Co. KG
Hans-Güntner-Straße 2 - 6
82256 Fürstenfeldbruck
www.guentner.de

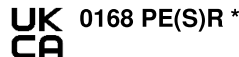
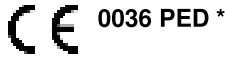

Projektnummer - Project number	101164186	
Gerätebezeichnung - Unit name	S-AGHN 080.2H/210-HND/12P.E	
Gerät Seriennummer - Unit serial number	405167157/43.01256	
Ventilator/ID/Drehzahl/Stromaufn. - Fan/ID/Speed/Current	VT03059U.2 / 3241 / 865 min -1 / 2,1 A	
Umgebungstemperatur - Ambient air temperature	-30 °C / +50 °C	
Herstellungsjahr - Year of manufacture	2022	
* Druckgerät Seriennr. - Pressure equipment serial no.	405167182/43.01264	
Volumen - Volume (V)	108.9 l	
Max. zulässiger Druck (PS) Max. permissible pressure (PS)	32 / 0 bar	0 / -1 bar
Zulässige min./max. Temperatur (TS) Permissible min./max. temperature (TS)	-50 °C / +150 °C	-50 °C / +40 °C
Prüfdruck(PT)/Prüfmedium - Test pressure(PT)/Test medium	35.2 bar / Druckluft - Compressed air	
Prüfdatum - Test date	20.01.2022	
Fluidgruppe / Zustand - Group of fluid / State	1 / gasförmig - gaseous	

2483 – Nameplate – **Sample image**



706** – Güntner logo (white colour for dark unit colour)

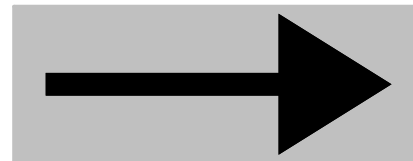

66824, 68909 – Inlet/outlet connections

3.3 Basic safety instructions

3.3.1 Please note

NOTICE

Only persons who meet the requirements for the personnel may work in the area of the unit (see section "Definition of the target group and requirements").
The operator must prevent persons under the age of 14 and unauthorised persons from gaining access to the unit.

NOTICE

Prior to all work on the unit and in case of danger respectively:

- Completely disconnect the unit and secure it against unintentional restart (lockable emergency stop switch is available or must be provided by the customer)
- Refer to the order documents for the permissible working fluid
- Observe the safety data sheets for the working fluid
- Wear personal protective equipment (PPE)

3.3.2 Electrical hazard

⚠ DANGER



ELECTRICAL VOLTAGE!

A short-circuit on the electrical connections and direct or indirect contact with live parts of the unit (including accessories and supply lines) can cause severe injury or even death. In addition, overvoltage or overheating of the electrical parts installed in the unit can result in fires which in turn can cause smoke inhalation injuries among bystanders.

The risk of electric shocks and short circuits increases with the degradation of insulating material due to environmental influences or mechanical and/or deliberate damage.









- Completely disconnect the supply line before performing electrical work on the unit (see the documentation for the plant as a whole).
- Work on the unit and the connection and control configuration must be performed by specialist staff.
- Check electrical components regularly, including testing in acc. with EN 60364-x/EN 60204-1. Consider the information provided in the connection diagram.
- Properly connect the unit to the building's earthing system.
- Perform earthing checks and visual inspections of the earthing points regularly.



3.3.3 Hazard due to working fluids

Working fluids pose various residual risks such as irritation, suffocation, poisoning, burns, frostbite, fire hazard and/or explosion hazard. Observe the following safety measures:



- Observe the safety data sheet of the working fluid.
- Comply with the safety regulations for the system in acc. with the EN 378 series of standards.
- Observe the pressure and temperature specified on the nameplate.
- Observe the type of fluid, the fluid charge and material selection in acc. with the technical data.
- Before performing any maintenance work, ensure that the unit is depressurised. Completely drain any working fluid from the unit if necessary.

⚠ WARNING		
    	<p>EXPLOSION HAZARD! FIRE HAZARD! RISK OF SUFFOCATION! RISK OF POISONING! RISK OF FROST-BITE!</p> <p>When working on the pipes of the heat exchanger (e.g. soldering or welding work), or if the flammable working fluid escapes through leaks and forms an explosive mixture over time, the working fluid catches fire or explodes and injures bystanders.</p> <p>Bystanders may inhale the escaped working fluid. Inhaling the working fluid causes anything from breathing problems to suffocation or poisoning.</p> <p>Contact with the working fluid can cause frostbite and/or irritation.</p> <p>Leakage of the working fluid can also lead to environmental damage.</p> <ul style="list-style-type: none"> • Drain the unit prior to work and for transport respectively. • Ensure that the operator provides appropriate fire-fighting equipment for soldering and welding work. • Ensure that the plant is designed in such a way that the unit can be filled/emptied safely. • Do not fill with a working fluid other than that specified in acc. with the order documents! • Take measures to prevent high working fluid concentrations on site. • Monitor the degree of icing regularly and observe the defrosting requirements. • Check the unit regularly for leaks and leakage (see section "Inspection/maintenance schedule"). Avoid leaks and leakage and, if necessary, have them fixed as quickly as possible by an expert. • Only put the unit back into operation when all leaks have been repaired. • Pay attention to the risk of ignition of oil residues carried over. • Avoid all sources of ignition when working! • Observe all applicable standards and directives with regard to waste disposal. • Wear personal protective equipment (PPE), including respiratory protection if necessary (see safety data sheet for the relevant working fluid). 	   

ATTENTION
<p>RISK OF FREEZING!</p> <p>Units filled with a coolant can be damaged or destroyed in frost if adequate frost protection measures have not been taken. There is a risk of freezing during pressure testing, operation, standstill or after draining units that cannot be completely drained.</p> <ul style="list-style-type: none"> • Ensure that the antifreeze concentration is sufficient. • Caution! The operator must ensure that the antifreeze concentration is sufficient. • When draining, the unit must be sufficiently ventilated!

3.3.4 Hazard due to vibrations

⚠ WARNING

EXPLOSION HAZARD, FIRE HAZARD, RISK OF PERSONAL INJURY AND DAMAGE TO PROPERTY CAUSED BY EJECTED OBJECTS!

A component, a chunk of ice or the complete fan unit loosens because of vibrations/oscillations/imbalance and

- injures bystanders or
- is thrown out of the unit by the fan's rotating movement and damages the heat exchanger whereby
 - the working fluid escapes and gets onto the skin of bystanders and/or is inhaled by bystanders (see section "Hazard due to working fluids"), or
 - the working fluid ignites (with flammable working fluids) and injures bystanders, or
 - a core tube that is under pressure explodes and the resulting pressure wave injures bystanders.

Take the following measures:

- Fans, components and pipes in the system must be designed, constructed and integrated in such a way that risks caused by vibrations are reduced to a minimum.
- Connect the fans in acc. with the motor connection diagram in the terminal box, check the connection and perform acceptance test of the fans.
- Check the fan unit regularly in acc. with the inspection and maintenance schedule.
- Keep the unit free of ice.
- Check the unit and especially the proper functioning of the fans after standstill periods.

⚠ WARNING





ADVERSE HEALTH EFFECTS AND DAMAGE TO PROPERTY CAUSED BY VIBRATIONS!

The operation of fans regularly causes vibrations that are increased by imbalances resulting from impurities, frost accumulation, icing or damage of fan blades. These vibrations are transmitted to the building and the unit and can result in damage to the building and the unit, and to the unit's suspension, the pressurised pipes/components and the system's components connected to the unit.





This can result in leakage of the working fluid and adverse health effects (see section "Hazard due to working fluids").

- Check the fan blades and protection guards regularly for impurities, frost accumulation, icing and snow accumulation, and make sure the fans run smoothly.







3.3.5 Hazard due to pressurised parts

 WARNING	
 	<p>EXPLOSION HAZARD! PERSONAL INJURY AND DAMAGE TO PROPERTY DURING OPERATION OR MAINTENANCE!</p> <p>The pressure in the heat exchanger exceeds the specified limit values (e.g. due to improper installation) and results in an explosion or breakage of pressurised pipes/components. This causes objects to be ejected and/or working fluid to be released, resulting in personal injury or damage to property.</p> <ul style="list-style-type: none"> • Comply with all regulations regarding installation, operation, maintenance and maximum permissible operating pressure. • Drain the unit prior to work and for transport respectively. • Ensure that the operator provides appropriate firefighting equipment for soldering and welding work. • Ensure that the plant is designed in such a way that the unit can be filled/emptied safely. • Monitor the degree of icing regularly and observe the defrosting requirements.







3.3.6 Thermal hazard

 WARNING		
 	<p>RISK OF BURNS OR RISK OF FROSTBITE!</p> <p>Contact with the working fluid (e.g. during filling/draining) or with the unit surface or pipes can cause severe burns/frostbite.</p> <ul style="list-style-type: none"> • Wear personal protective equipment (PPE). • Monitor the degree of icing regularly and observe the defrosting requirements. • Retrofit a thermal insulation to the pipes and the connection system as required. • If necessary, wait until the temperature has equalised to the ambient temperature before starting to work. 	 

3.3.7 Mechanical hazard

⚠ WARNING		
	<p>RISK OF INJURY! Due to overloading or external influences such as extreme, impermissible ice loads on the unit, the unit loses the holding force of the attachment and tips over or falls down, or structural failure occurs and the unit breaks apart. Bystanders are seriously injured.</p> <ul style="list-style-type: none"> • If the unit reaches its load limits (e.g. ice load), defrost the unit properly and perform an inspection of the unit. • Install the units at the corresponding fixing points. The operator or installer is responsible for ensuring that the connecting elements (screw connections) are of an adequate strength. • Tighten the fixing bolts evenly to achieve an even load distribution on the unit's fastenings. • Anchor the unit in its fixing position to prevent it from moving. • Secure fixing bolts against loosening by means of appropriate locking devices. • Regularly check all fixing bolts and attachments for corrosion damage, loading-bearing capacity and structural integrity, and replace them if necessary, especially before and after lifting the unit. 	
⚠ WARNING		
	<p>RISK DUE TO FALLING OR EJECTED OBJECTS! A component or chunk of ice can come loose owing to vibrations, is being ejected from the unit because of the fan rotation and can injure bystanders.</p> <ul style="list-style-type: none"> • Check the fan unit regularly in acc. with the inspection and maintenance schedule. • Check the unit and especially the proper functioning of the fans after standstill periods. • Defrost the unit properly and keep it free of ice (ice thickness ≥ 1 mm not permissible). 	
⚠ WARNING		
 	<p>RISK OF CUTTING AND CRUSHING! Persons can cut or otherwise injure themselves on the packaging (e.g. wood) or on sharp edges of the unit (e.g. sheet metal edges/fins) or the accessories. There is a risk of crushing when the unit is open.</p> <ul style="list-style-type: none"> • Wear personal protective equipment (PPE). • The hinged or removable components (e.g. side plates/trays (if any)) may be opened only by trained specialist staff and only for the purpose of maintenance and repair. Once the work has been completed, the components must be closed and secured against unintentional or unauthorised opening. 	 

3.3.8 Hazard due to fans

⚠ WARNING		
  	<p>DANGER OF PULLING IN, RISK OF CRUSHING AND DANGER OF CUTTING OFF!</p> <p>Limbs can be caught by the running fan or pulled into the running fan and injured (e.g. crushed) or severed. Hair and clothing can be pulled in the running fan and cut off.</p> <ul style="list-style-type: none"> • Completely disconnect the unit and secure it against unintentional restart before performing any work. • Ensure that the fans are connected in acc. with the motor connection diagram in the terminal box, then perform an acceptance test of the fans. • Operate the fans only with protection guards. • The protection guards must be opened by trained specialist staff and only for maintenance and repair purposes. • Check the fan unit regularly in acc. with the inspection and maintenance schedule. • Do not wear any loose clothing or jewellery. Secure long hair on the head. • Transport screws have to be attached to the fan plate prior to each transport and to be removed after transport. • Wear personal protective equipment (PPE). • Stop the unit immediately if a missing or ineffective safety device is detected. • Check the unit and especially the proper functioning of the fans after standstill periods. • Keep the unit free of ice. 	  

3.3.9 Other hazards

⚠ WARNING	
	<p>RISK OF HEARING DAMAGE!</p> <p>Persons who spend long periods in the vicinity of the unit can suffer hearing damage, discomfort and stress as the unit produces noise levels (sound pressure levels) of over 70 dB(A).</p> <ul style="list-style-type: none"> • Wear personal protective equipment. • Observe the requirements of local authorities. • The manufacturer of the system is obliged to position the unit in such a way that noise pollution is minimised. In addition, further suitable measures must be taken to minimise noise.

⚠ CAUTION**RISK OF INFECTION!**









During operation, cleaning or defrosting of the unit, water can accumulate, especially in hard-to-reach areas with insufficient slope. Standing water, in turn, results in the formation and proliferation of germs which can be released into the ambient air when the unit is switched on again. This can infect bystanders and contaminate the refrigerated goods.

- The operator must ensure that the tray has a sufficient slope for water drainage and that the drain of the tray is kept clear.
- Clean the unit regularly and observe hygiene regulations.
- Define cleaning intervals in relation to the requirements of the respective applications.



3.3.10 Hazards due to accessories

4 Transport and unpacking

4.1 Safety instructions for transport and unpacking

⚠ WARNING		
	<p>RISK OF INJURY OWING TO STRONG IMPACTS! RISK OF CRUSHING AND SHEARING!</p> <p>The following hazards may occur:</p> <ul style="list-style-type: none"> • When transporting or manoeuvring the means of transport, bystanders are caught by the unit. This causes serious impact injuries, or limbs are sheared off/crushed. • Bystanders get under the unit or are caught by a falling component/unit and lose limbs or are crushed. • The unit loses its stability due to accelerations during transport and falls over or falls from the goods vehicle. Bystanders are seriously injured. • Attempting to transport the unit by hand causes injury (e.g. to the spine) due to the lifting of an overload. <p>Take the following measures:</p> <ul style="list-style-type: none"> • Transportation including loading and unloading only by specialist staff. • Do not stand in the loading/danger zone under or in the vicinity of suspended loads. • Ensure that the unit is protected against slipping and mechanical damage. • Remove foreign material before lifting the unit, and sweep off snow. • Ensure that the unit is not filled during transport. • Suspend or position the unit so that it has a stable centre of gravity. • Use appropriate lifting or tie-down points. • Use suitable tools and working equipment. • Do not lift the unit in strong winds. • Observe maximum permissible total weight. • Wear personal protective equipment. 	
		
		
		
		

⚠ CAUTION	
	<p>RISK OF SLIPPING!</p> <p>The hose of the condensation water pump has slipped due to transport and no longer sits correctly at the suction point in the tray. As a result, the pump can no longer remove water by suction, the water escapes from the unit and drips onto the floor. Persons standing under the unit can slip because of the escaped water.</p> <ul style="list-style-type: none"> • Perform a visual inspection of the pump regularly. Check the hose for proper fit at the suction point in the tray and for clogging.

⚠ CAUTION	
	<p>RISK OF INJURY WHEN UNPACKING! Dust and wood particles can get into the eyes when removing the film.</p> <ul style="list-style-type: none"> • Wear personal protective equipment. • Use appropriate tools.
	

ATTENTION
<p>The lifting capacity of the means of transport must be at least 1.5 times the weight of the unit.</p> <p>Do not use connection pieces and outlet headers as attachment points for lifting, pulling, fixing and climbing. This can result in leakage.</p>

NOTICE
<p>Observe all basic safety instructions (see section "Basic safety instructions").</p>

4.2 Transport and storage of the unit

4.2.1 Transporting the unit

NOTICE
<p>Read and observe the transport sign on the unit packaging!</p> <p>Permanent mechanical load caused by uneven road surfaces and potholes, and vibrations during ship transport, can result in transport damage.</p> <ul style="list-style-type: none"> • Mounted parts that can be induced to vibrate – particularly fans and bases (if any) – must be removed prior to maritime transport or in countries with critical traffic routes. • Supports of outlet headers and flanges must be added if required. • After transport, all bolted connections, especially on EC fan terminal boxes, must be checked and retightened if necessary (for tightening torque values, see section "Fans").

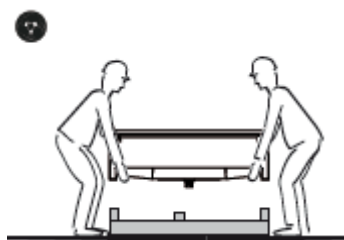

Units with one fan can be lifted and transported by two persons.

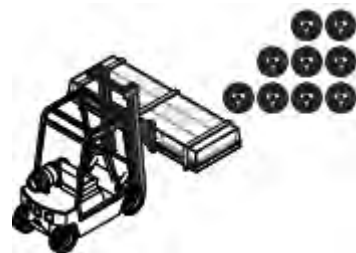

For units with 2 – 4 fans, use a suitable means of transport.

- ⇒ Unload the unit.
- ⇒ Transport the packed unit by 2 persons or with suitable transport equipment (e.g. industrial truck with forks) to the final place of installation.
NOTE: Place the unit on a pallet for transport with an industrial truck with forks.

NOTICE

Before lifting the pallet with an industrial truck with forks, slide the forks far enough underneath the open spaces of the pallet so that they reach to the end of the pallet.

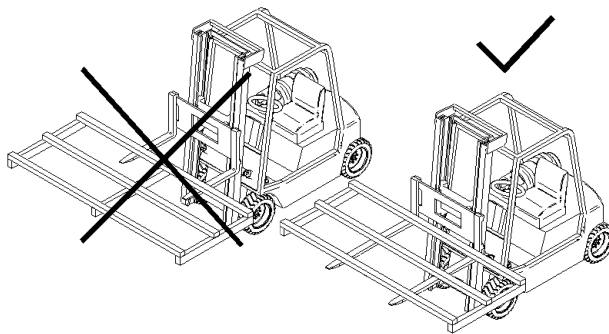

4.2.2 Storing the unit prior to installation

- ⇒ Protect the unit against dust, dirt, moisture and wetness, damage and other harmful influences until it is mounted.
- ⇒ For storage periods of more than one month: Operate the fans at least once a month at full speed for at least three hours so that the bearings move and any penetrated condensate can evaporate. Check, once a month and prior to installation, if the transport pressure is still present to ensure that the unit is leak-tight. If the pressure is too low or if there is no transport pressure at all, be sure to contact the service department of the manufacturer. Before moving the unit to the installation site, check the load capacity and structural integrity of the crane lugs and replace them if required. Store the unit only in its original packaging until installation.
- ⇒ If the unit installation is delayed beyond the initial deadline scheduled for installation: Protect the unit against weather and other harmful effects and dirt with an appropriate tarpaulin. In this context, ensure good ventilation of the unit.

4.3 Unpacking the unit

Introduction

The units are delivered in the installation position and with mounted tray.

Unpacking the unit

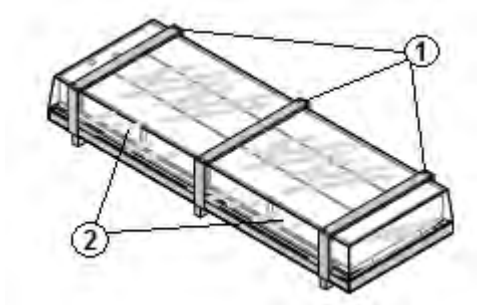

- ⇒ Remove the transport protection (1).
- ⇒ Remove the film (2) from the unit.
- ⇒ The transport rack is subsequently used to lift the unit for mounting at the place of installation (see section "Installing the unit").
- ⇒ Remove unit from packaging: For lifting, slide the fork under the transport frame.

After unpacking

- ⇒ Dispose of packaging material.
- ⇒ Check scope of delivery for completeness. For the scope of delivery, refer to the order documents.
- ⇒ State transport damages and/or missing parts on the delivery notes. Immediately notify the manufacturer in writing about the matter. Damaged fins can be repaired on site using a fin comb.
- ⇒ Check the transport pressure (see below).

NOTICE

Güntner GmbH & Co. KG's transport packaging is made from environmentally sound material and is suitable for recycling.

4.4 Checking the transport pressure

Introduction

The section applies only to units supplied with transport pressure.

All units are delivered by the manufacturer with approx. 1 bar of transport pressure (cleaned and dehumidified air). The transport pressure is used to check the leak tightness.

Specific hazards

⚠ CAUTION	
	<p>RISK OF DAMAGE TO PROPERTY! The unit is pressurised! An unpressurised unit indicates a leak due to transport damage.</p> <ul style="list-style-type: none"> • Do not put the unit into operation! • Immediately report any pressure drop of the unit to the manufacturer and note it on the delivery note.

Procedure after receiving the unit

⇒ Read the transport pressure on the Schrader valve (pressure measurement).

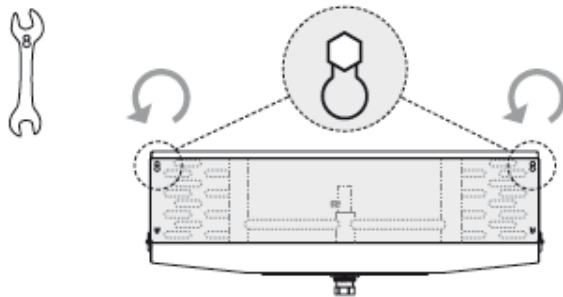

⇒ Loosen both bolts on the inlet side at the upper corners of the side plate.

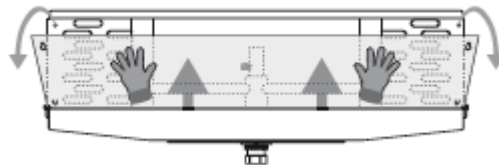

⇒ Slide the plate upwards.
 ⇒ To remove, pull the plate forwards.

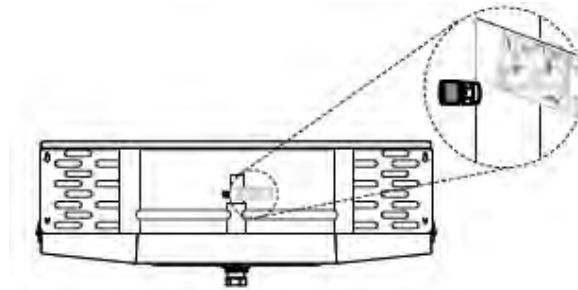

⇒ Note the details on the tag of the valve.

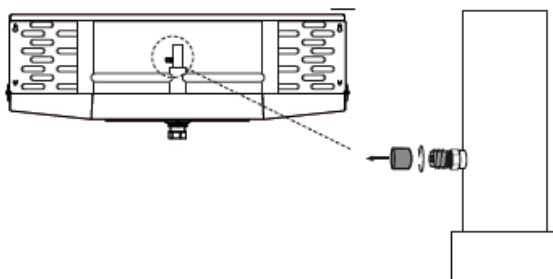

⇒ Loosen the cap of the valve.

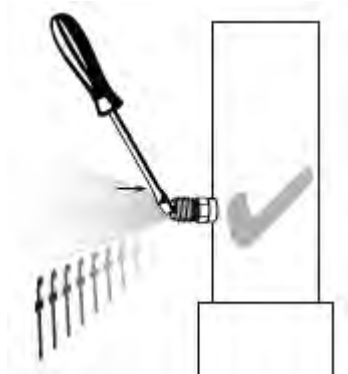

⇒ Check if there is transport pressure.

Procedure immediately before the installation

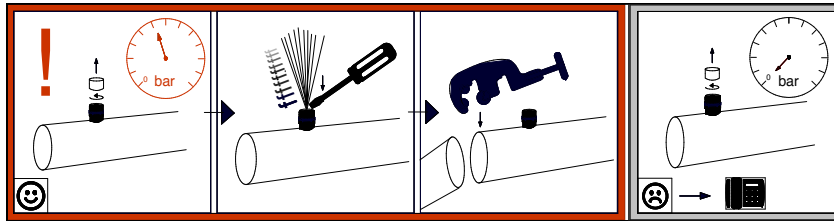

In the case of factory-sealed pipe ends without flanges

- ⇒ Check the transport pressure (attach a pressure gauge to the Schrader valve and read the pressure) and then release it.
- ⇒ Cut off the sealed pipe ends without flanges from the pipes (e.g. with a suitable saw).
Caution! The sealed pipe ends must not be cut off more than 2 cm from the end.



5 Installation and commissioning

5.1 Safety instructions for installation and commissioning

Please note

NOTICE
Observe the basic safety instructions and the safety instructions for transport (see sections "Basic safety instructions" and "Safety instructions for transport and unpacking").
NOTICE
Observe the earthing marking on the unit. Ensure professional equipotential bonding to protect any warranty claims.
NOTICE
Mounting/installation must be performed by competent persons. The manufacturer's warranty does not cover damage resulting from improper installation.
NOTICE
During filling and after filling the system, properly vent the heat exchanger. To do this, keep the vent connections open until no more air escapes from the unit! Observe the safety data sheets of the working fluid used!
NOTICE
After commissioning, document the installation and settings and have them signed by the responsible persons.

Specific hazards

⚠ WARNING	
	<p>RISK OF DAMAGE TO PROPERTY! In order to avoid stray currents, heat exchanger tubes, casing parts and the like must not be used as return line when performing welding work as these load-bearing components and lifting accessories are not designed for high welding currents. If not observed, unintended or improper current flow can damage heat exchanger pipes of the unit and lead to damage during operation.</p> <ul style="list-style-type: none"> Securely connect the insulated welding return line to the workpiece to be welded directly at the welding point.
⚠ CAUTION	
	<p>FIRE HAZARD! As a result of high tolerance errors, the fan blade can rub against the nozzle when connecting the fans. This causes sparks and may ignite surrounding flammable materials.</p> <ul style="list-style-type: none"> The tray has to be pushed upwards every time it is closed so that the quick-release couplings named "SnapLocs" (ensuring the tray is locked) click into place.

ATTENTION**RISK OF DAMAGE TO PROPERTY!**

To prevent damage to the heat exchangers, always connect them without force and torque. There must be no forces or moments acting on the heat exchanger at any time. Failure to observe this can result in leaks and further damage to the heat exchanger in the short and medium term.

- Ensure that the outlet headers and flanges (if any) are not used as a climbing aid. They are not designed for external forces.
- Ensure that no forces or moments act on the heat exchanger at any time by using suitable fixed bearings during pipe installation.

5.2 Requirements for the place of installation

Dimensions/weights

For dimensions and weights, refer to the order documents.

Environmental conditions

The unit is designed for the following ambient conditions:

- Ambient temperatures ranging from -25 °C to +45 °C
- At fluid temperatures below 0 °C, frost and ice is likely to form.

The material selection of all components must be suitable for the local conditions.

Load limits

The unit is subject to the following load limits:

- Max. ice load on the heat exchanger: 1 mm on the fins
- Max. ice load on casing parts and accessory parts: 0 mm
- Max. ice load on refrigerating system components: 1 mm

Installation conditions

- ⇒ The place of installation must have sufficient load-bearing capacity.
- ⇒ A stable and flat floor/ceiling is required for mounting.
- ⇒ The layout plan must be drawn up by the system operator.
- ⇒ Position the unit in such a way that it is safe to reach and cannot be damaged by internal traffic or transport processes or by other environmental hazard sources (e.g. processes at the place of installation).
- ⇒ Position the units in such a way that the air flow is not impeded by obstacles.
- ⇒ Place the unit so that it can be monitored and checked from all sides at all times.
- ⇒ Ensure that sufficient space is available for maintenance.
- ⇒ Ensure that all working fluid-carrying components, connections, shut-off devices and pipes and all electrical connections and lines are easy to access.
- ⇒ If electric defrost is used, ensure that there is free space for unobstructed exchanging of heating rods (accessory at customer's request).
- ⇒ Ensure that the labelling of the pipes is easily visible.

- ⇒ Ensure that there is sufficient free space on the side of the unit (e.g. the side distance from the unit to any possible obstructions) and under the unit so that the hinged side plates and the tray can be opened and closed in a safe and obstruction-free manner.
- ⇒ The unit must be securely fixed at all fixing points without vibration.

NOTICE

The operator or installer of the equipment is responsible for ensuring that the bolted connections are of an adequate strength.

Mounting overview

Schematics without options/mounted parts/accessories:

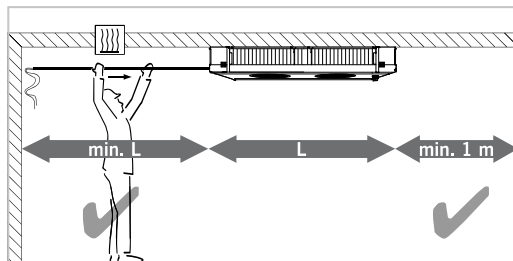

Minimum distance to the wall and between the units:

The minimum distance corresponds to the length of the unit so that the unit does not have to be removed when replacing or retrofitting heating rods.

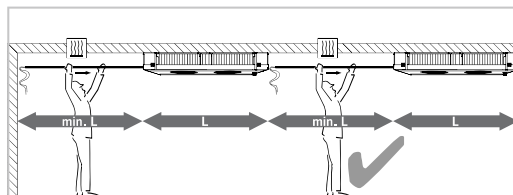

Free air flow

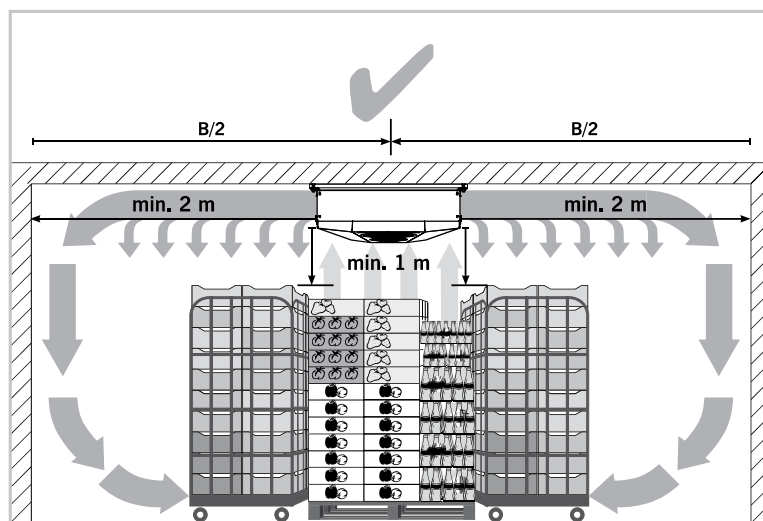

Ensuring the proper functioning of the equipment:

- ⇒ Position the unit centrally on the longitudinal axis of the room.
- ⇒ Ensure that the air flow can circulate freely.
- ⇒ Keep a minimum distance of 1 m between the unit and the refrigerated goods.

5.3 Installation of the unit

5.3.1 Installing the unit

Required staff

- The installation must be performed by at least two people.

Auxiliary equipment/tools

- Lifting accessories and lifting gear
- Climbing aids
- Fasteners (fixing bolts/nuts, washers and rawlplugs)
- Master gauge for holes (see section "Versions")
- Writing materials
- Required measuring equipment
- Drilling tool
- Spanner or appropriate assembly tools for screws and nuts

Note: Choose the tools that are best suited to the task at hand.

Provisions for fixing

- Prevent mechanical stress on the unit as follows:
 - Ensure that all fixing points are at the same distance from the fixing level and that this distance is maintained permanently even under load.
- At the place of installation, bolt the units into place via all available fixing points using fixing bolts with washers. The fixing points must support the weight of the respective unit. The operator or installer of the equipment is responsible for ensuring that the bolted connections are of an adequate strength.
- Observe the following instructions when fixing the units:
 - The diameters of the mounting holes have been statically determined by the manufacturer; use suitable fixing bolts and washers. When calculating the bearing strength, it is imperative to take into account the total weight of the unit (= structural weight of the unit + weight of tube volume + additional weight such as moisture, ice and dirt).
 - Secure fixing bolts against loosening by means of appropriate locking devices.
 - The fixing bolts must not be overtightened.
 - All fixing screws must be tightened equally.
- Fix the unit in position and secure it against moving.
- Ensure that the drip water drains properly. Set up the unit horizontally in a level position. The units are delivered in the installation position and with mounted tray.
- Use the fixing points provided to fix the unit. Tighten all fixing bolts evenly to achieve the most even load distribution possible.

Hole pattern

NOTICE

Note in the hole pattern that the fixing points are not arranged symmetrically!

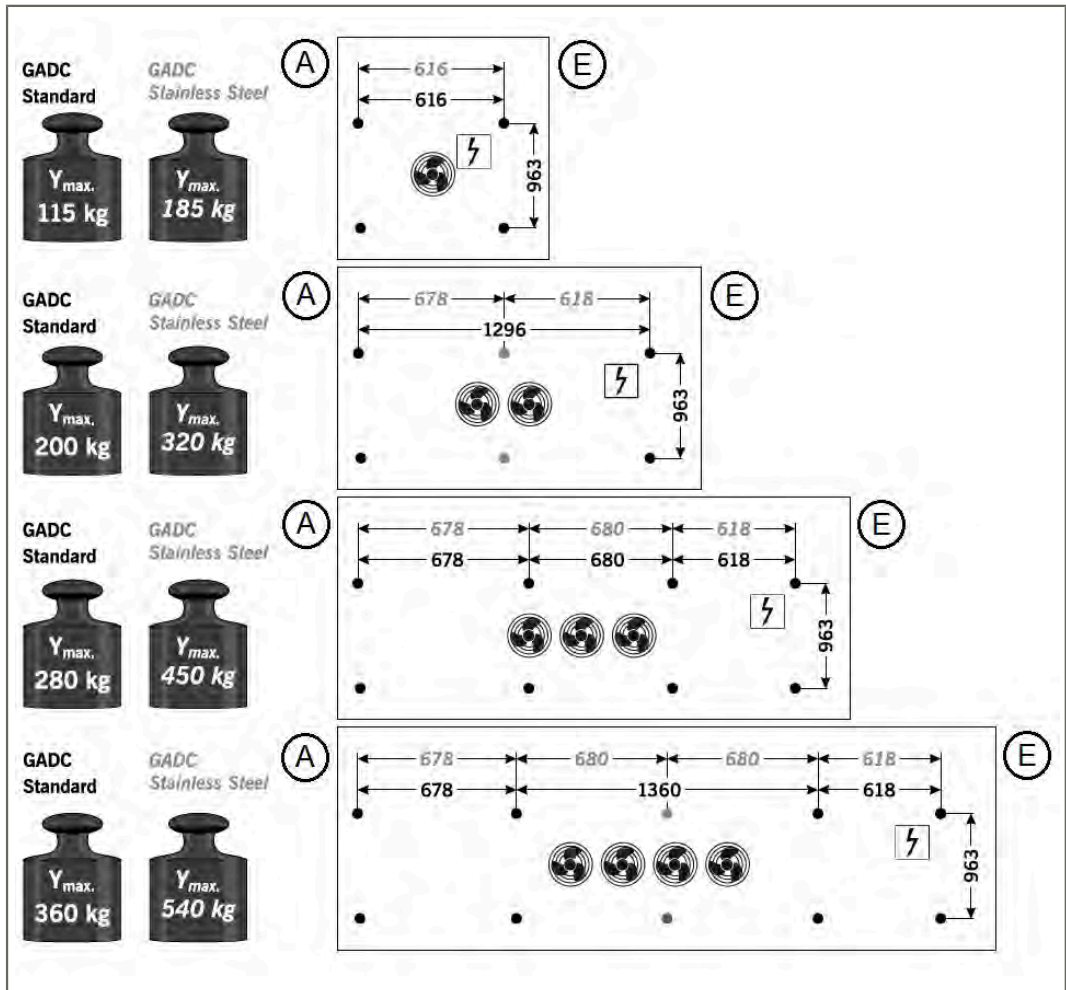

- A Inlet side (side plate has square perforations)
- E Electrical connection side (side panel has round perforations)

Procedure

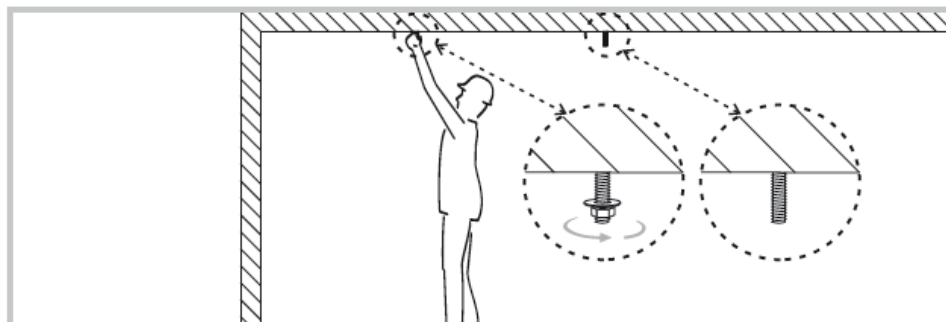

- ⇒ Make holes for the screws in the ceiling in acc. with the hole pattern.
Note: On the air discharge side, the minimum distance between the unit and the ceiling or an obstacle must be 75 % of the air throw (see GPC data sheet).
- ⇒ On one side, screw the washer and the nut with just a few turns in order to be able to hang the unit on this side.

Units with 1 fan

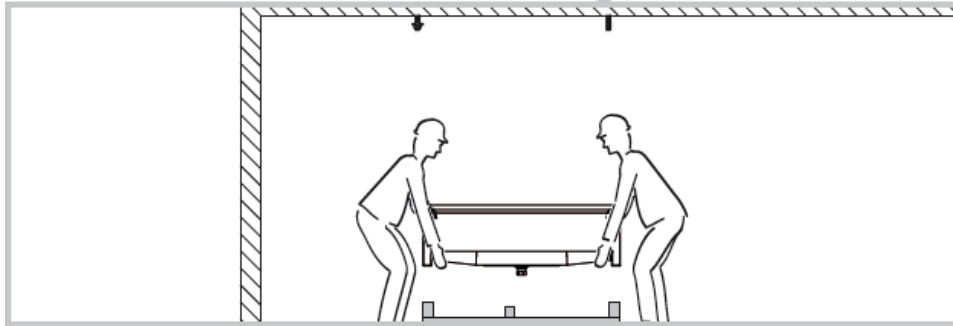

- ⇒ 2 persons are required to lift the unit from the transport rack per hand using the legs for floor mounting.

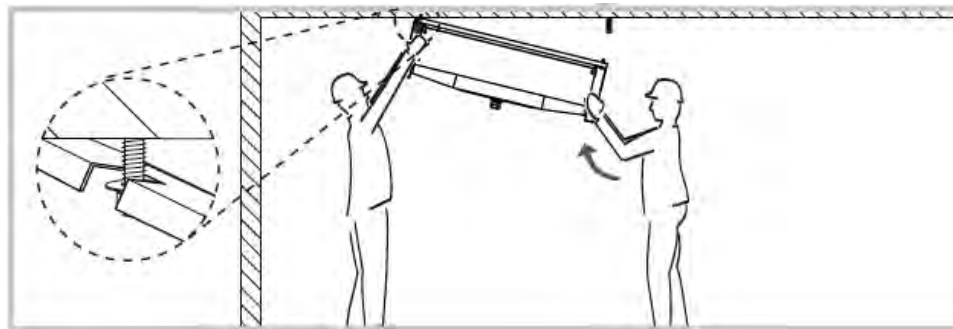

- ⇒ First hang the unit on the side with the nut already screwed in (see detailed image).
- ⇒ Lift the unit on the other side up to the bolts.
- ⇒ Tighten all fixing bolts equally to achieve a load distribution that is as balanced as possible.

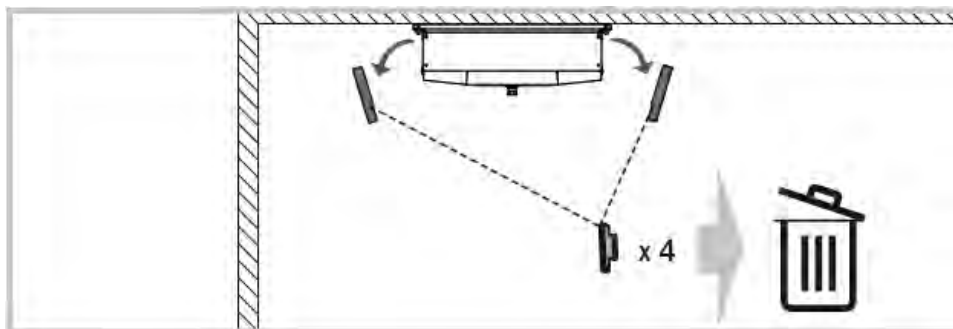

- ⇒ Remove the legs for floor mounting from the unit and dispose of them.

Units with 2 – 4 fans

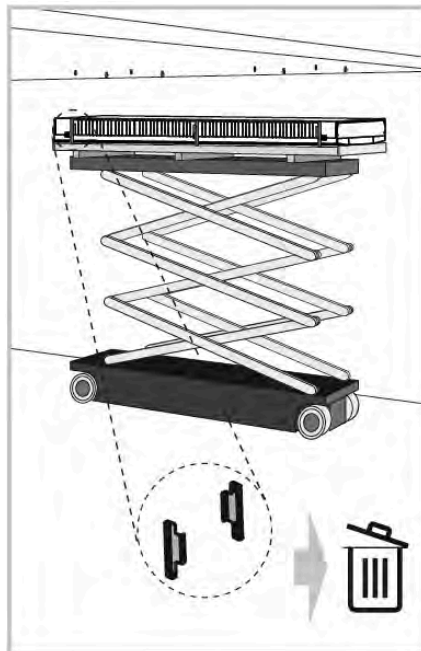

- ▶ Make holes for the screws in the ceiling in acc. with the hole pattern.
- ▶ Lift the unit on the transport rack to the ceiling using lifting gear.
- ▶ Bolt the unit to the ceiling. Tighten all nuts evenly.
- ▶ Press at the points where the 66557 labels are (see "Labelling on the packaging/the unit") until the SnapLoc fastener locks into place so that the tray does not unhinge and the fans do not damage the casing.
- ▶ Remove the legs for floor mounting.

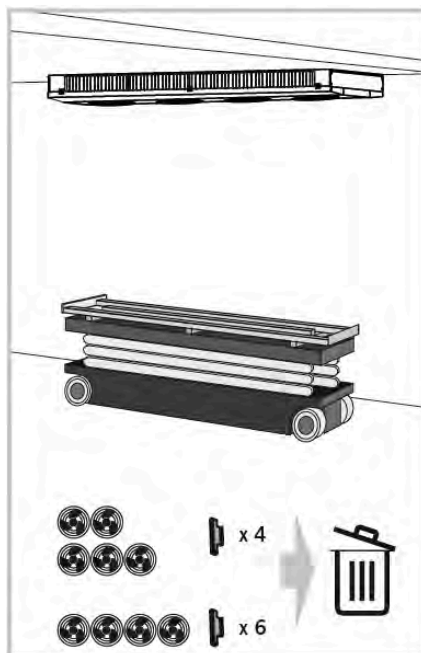

- ▶ Dispose of the legs for floor mounting (4 legs each for units with 2 or 3 fans; 6 legs each for units with 4 fans).

5.4 Connecting the unit

5.4.1 Connecting the unit to the plant

Safety

⚠ WARNING	
	<p>RISK OF PERSONAL INJURY AND DAMAGE TO PROPERTY! Improper connection to the system will result in leaks that will lead to the escape of working fluid and corresponding risks (see section "Hazard due to working fluids").</p> <ul style="list-style-type: none"> • Follow the instructions for connecting the unit and pipes. • Refrigerant detectors and alarm systems to warn of the risk of explosion and fire, concentrations hazardous to health (e.g. with NH₃ and HFC) and for control purposes must be installed at the place of installation of the unit in acc. with EN 378-3.
ATTENTION	
<p>RISK OF DAMAGE TO PROPERTY DUE TO IMPROPER VENTILATION! Without proper ventilation, the unit can be damaged or destroyed by freezing liquid (in the case of water/glycol).</p>	
NOTICE	
<p>Observe all safety instructions on the installation and commissioning (see section "Safety instructions for installation and commissioning").</p>	

Distributor connection (only applicable to RX and CX)

Connect the distributor to the system in acc. with the following instructions:

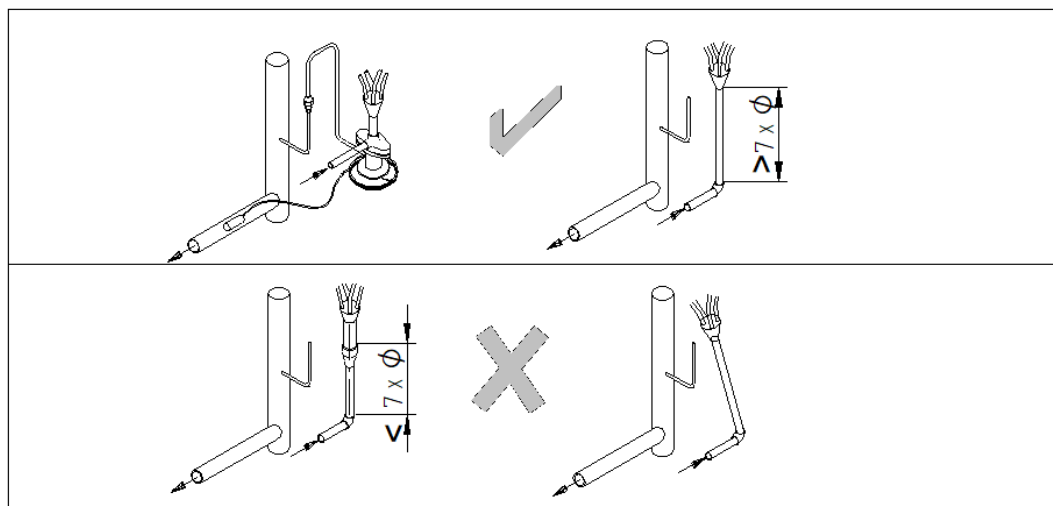

NOTICE

After installation, check the capillary tubes of the distributor for free movement. Vibrations can result in mechanical damage and leaks. It is therefore essential to align or additionally secure the capillary tubes (e.g. using plastic cable ties).

Important notes on connecting the unit

- Regarding welding work: Observe the safety instructions on connecting the welding return line (see "Safety instructions for installation and commissioning").
- Perform soldering and welding work only on unpressurised units .
- Ensure that mechanical stresses and vibrations from the system are not transferred to the unit.
- It is imperative that working fluid connections are installed without tension and protected against linear thermal expansion and vibrations using horseshoe expansion joints or pipe compensators.
- Support the on-site piping with at least two fixed points before connecting to the unit.
- Never use pliers for the tray drain! Tighten by hand!
- With the water/glycol working fluid: In addition, use a wrench/spanner to counterhold when connecting and disconnecting the threaded connections of pressurised pipes and components to prevent leaks.
- With the water/glycol working fluid: Use water of drinking water quality.

Installation notes on pipes

- The connections are easy to access thanks to the hinged tray.
- Keep the installation of pipes as short as possible; use as few bends as possible, and only those with large radii, to minimise the pressure drop.
- External loads must not act on the pipes and unit connections.
- Lay pipes (liquid and discharge lines, supply and return lines) separately from each other and insulate on both sides.
- Ensure that pipes are secured against vibrations, mechanical stresses and force transmission due to linear expansion.
- The free space around the unit must be large enough so that the following measures can be carried out:
 - Regular maintenance of the components
 - Checking of components, pipes and fittings
 - Repairs
- It must be possible to shut off the unit if a leak occurs.

Procedure

- ⇒ Install the pipes in acc. with EN 378-1 and EN 378-3.
- ⇒ With copper, the connection to the system must be soldered.
- ⇒ With units with threaded connections/flanges, bolt the connections together.
- ⇒ In the case of threaded connections, prevent the pipe from twisting by holding it in place.
- ⇒ When brazing, observe the following:
 - Braze all connections!
 - Avoid end-to-end joints; use copper pipe ends expanded on one side (capillary brazing)!
 - Avoid leaks, braze conscientiously and carefully!

- Avoid overheating when brazing (risk of excessive scaling)!
- Use shielding gas when brazing (to avoid scaling)!

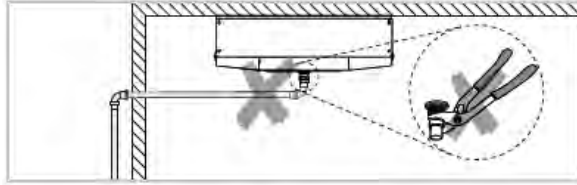

- ⇒ Tighten the condensate drain only by hand. Do not use pliers under any circumstances!
- ⇒ Always use a siphon.

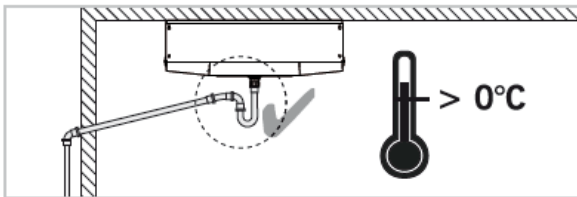

- ⇒ For rooms with temperatures > 0 °C, install the siphon directly under the condensate drain.

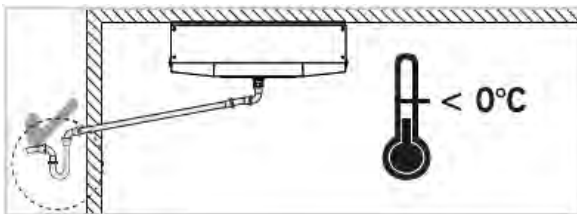

- ⇒ For rooms with temperatures < 0 °C, install the siphon outside the room.

► After installation, check that the connections are tight.

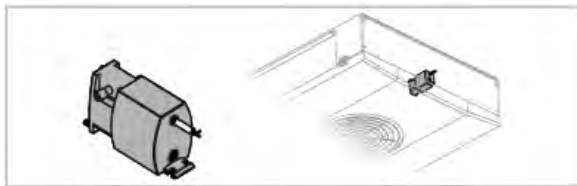

- ⇒ The use of a condensate pump is permissible only with fluid temperatures > 2 °C.

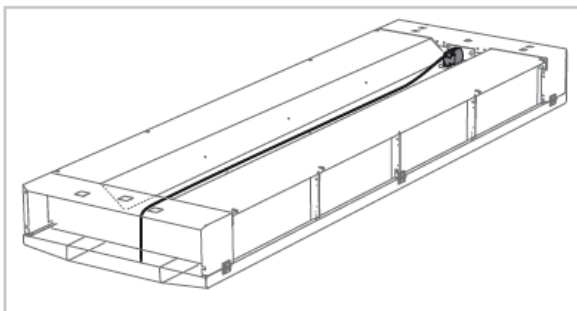

- ⇒ Use the hose provided.

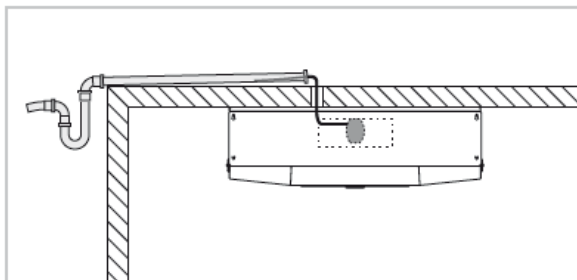

- ⇒ Connect the hose to the sewer line.
- ⇒ Seal the connection with a plug.

5.4.2 Connecting the drain line to the tray

Requirements

- The diameter of the drip tray drain line must be at least that of the drip tray drain of the unit.
- The drip tray drain line should be laid with a downward slope of 3° to 5°.

Installation notes

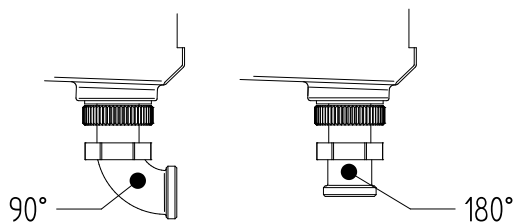

Pipe routing (schematic)

- Recommended pipe routings:
 - Continuation through 90° bend
 - Continuation downwards
- Sealing of the connected drain line with a flat gasket pressed on the pipe connectors (cylindrical G thread in accordance with DIN ISO 228-1).
 - Do not seal with Teflon tape
 - Do not seal with hemp

Overview

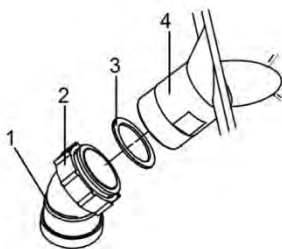

Connecting the drain line (schematic)

No.	Designation
1	Drain line
2	Connecting nut
3	Flat gasket
4	Drip tray drain

Procedure

- ⇒ Lay the drain line (1) without applying any tension
- ⇒ Insert the flat gasket (3) between the connecting nut (2) and the drip tray drain (4)
- ⇒ Tighten the connecting nut by hand.

ATTENTION

RISK OF DAMAGE TO PROPERTY!

When using pliers, the plastic thread can be damaged by overstretching. This will lead to leaks with dripping water damage to the goods to be cooled.

- Do not use pliers to tighten the connecting nut!

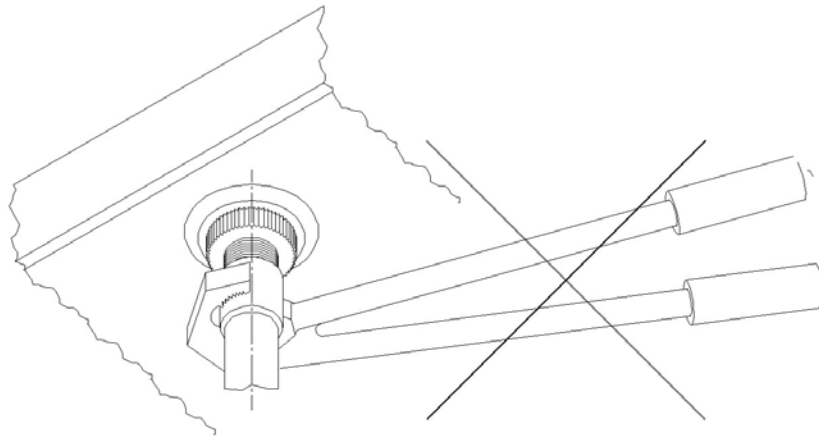

5.5 Electrically connecting and protecting the unit

Introduction

Each unit is designed for a specific fan speed in acc. with the data sheet and wired accordingly. Some fans provide the option of a second, reduced speed or a continuous control as a standard. For details, refer to the corresponding connection diagram. Changing the fan speed can have a negative impact on the thermodynamic configuration of the unit.

Interfaces

As interfaces to the electrical equipment, there are terminal boxes and switch cabinets for the electrical supply and signal exchange (see connection diagrams and manuals of the control systems).

Procedure

- ⇒ Connect the unit to the power supply in acc. with the connection diagram.
- ⇒ Use the prepared thermocontacts to protect the motors to safeguard any warranty claims.
- ⇒ If electric defrosting is used, connect the electrical feeds for the heating rods in acc. with the connection diagram when required.

- ⇒ Place the defrost limit sensor in acc. with section "Defrosting functions".
- ⇒ Perform all electrical lines in acc. with the connection diagram, taking into consideration the EN 60204-1 and national regulations respectively.

5.6 Connection diagrams

Connection diagram for fan motor

- See inside the motor terminal box at the fan or in the terminal box of the unit
- See order documents

Connection diagram for electric defrost (optional; accessory at customer's request)

- See inside the terminal box of the electric defrost heater
- See order documents

Connection diagram 0-10 V control

- See inside the unit's terminal box
- See order documents

5.7 Performing an acceptance test

Specific hazards

⚠ WARNING	
	<p>RISK OF PERSONAL INJURY AND DAMAGE TO PROPERTY! Escaping working fluid can cause personal injury (see safety instructions regarding working fluids in section "Basic safety instructions").</p> <ul style="list-style-type: none">• Have the following acceptance test performed by a competent person before commissioning the unit, after making important changes to the unit and after replacing the unit.

Requirements

- The acceptance test must be performed by the manufacturer of the system!
- The temperature and humidity at the place of installation correspond to the permissible operating range (see section "Technical data of the unit").

When to perform an acceptance test

- Before commissioning the unit
- After making important changes to the unit
- After replacing the unit

Procedure

- ⇒ When operated with water, the unit must be put into operation quickly after initial filling (maximum two weeks) to prevent pitting corrosion caused by stagnant water.
- ⇒ Ensure that sufficient air can be sucked in and blown out.
- ⇒ Ensure the power supply is sufficiently dimensioned: Compare the connection diagram of the unit with the connection diagrams of the complete system.
- ⇒ Ensure that a professional equipotential bonding has been performed.
- ⇒ Check the unit for vibrations and movements that could be caused by the operation of the fans or the plant. Eliminate vibrations and external forces, following consultation with the manufacturer if required.
- ⇒ Perform a visual inspection of the structural design, the brackets and fastenings (materials, connections), the operability and the arrangement of the fittings.
- ⇒ Check all threaded connections on the fans and tighten them if necessary in acc. with the following table.

Screw/bolt	Type of bolt	Tightening torque
M6 (property class 8.8)	Cage nut/snap nut	10 Nm
M8 (property class 8.8)	Cage nut	23 Nm
M8	Nut (SST)	23 Nm

- ⇒ Check all other threaded connections and tighten if necessary.
- ⇒ Check the pipe connections.
- ⇒ Check that working fluid-carrying pipes are laid correctly.
- ⇒ Ensure that the unit is protected against mechanical damage.
- ⇒ Ensure the unit is protected against excessive heating up and cooling down.
- ⇒ Check the protection guards for damage.
- ⇒ Ensure that the unit can be inspected at any time and is always freely accessible:
 - Is the unit positioned so that it can be monitored and checked from all sides at all times?
 - Is sufficient space available for maintenance?
 - Are all working fluid-carrying components, connections and pipes and all electrical connections and lines easy to access?
 - Are the pipe identifications easily visible?
- ⇒ Check heat exchanger surfaces for dirt and clean if necessary (see section "Cleaning the coil").
- ⇒ Perform a function test on the fans (rotation direction, power consumption).
- ⇒ Check the wiring of the fans and the optional electric defrost heating for damage.
- ⇒ Check the quality and execution of all connections (soldered connections, electrical connections and fixing connections).
- ⇒ Be sure to perform a pressure test in acc. with EN 378-2.
- ⇒ Perform a system test in acc. with the locally applicable regulations, e.g. EN 378-2 for the European region.
- ⇒ Check the corrosion protection: Perform a visual inspection of all pipes, components and component holders that are not heat-insulated. Document and archive the test results.
- ⇒ Perform a test run. Observe and check the unit during the test run, in particular for:
 - Quiet running of the fans (bearing noises, contact noises, imbalances, among other things)
 - Current consumption of the fans
 - Leaks

Procedure in case of defects

- ⇒ Report all defects to the manufacturer immediately.
- ⇒ Rectify the defects only upon consultation with the manufacturer.

Check after 48 operating hours

- ⇒ Check the unit and the unit's interaction with the system (cooling equipment and refrigeration system) again after approx. 48 operating hours, especially at the connections and at the fans.
- ⇒ Document the test result.

6 Operation

6.1 Safety instructions for operation

Please note

NOTICE
Observe the basic safety instructions (see section "Basic safety instructions").

Specific hazards

⚠ WARNING	
	<p>RISK OF PERSONAL INJURY AND DAMAGE TO PROPERTY! Escaping working fluid can cause personal injury (see section "Hazard due to working fluids").</p> <ul style="list-style-type: none"> Put the unit into operation only if all requirements are met (see section "Putting the unit into operation"). Ensure that the maximum operating pressure is never exceeded (also after shutdown)!

⚠ CAUTION	
	<p>RISK OF SLIPPING! The hose of the condensate pump becomes clogged during operation. As a result, the pump can no longer remove water by suction, the water escapes from the unit and drips onto the floor. Persons standing under the unit can slip because of the escaped water.</p> <ul style="list-style-type: none"> Perform a visual inspection of the pump regularly. Check the hose for proper fit at the suction point in the tray and for clogging.

⚠ CAUTION	
	<p>RISK OF INJURY! In case of failure of the pump, water enters the tray and subsequently freezes. Masses of water or ice may fall down when hinging down the tray.</p> <ul style="list-style-type: none"> Check the pump at regular intervals (visual inspection). Check the level in the tray and the flow rate of the pump.

⚠ CAUTION	
	<p>RISK OF INFECTION! A failure of the pump results in the fact that the forming condensate cannot be drained. In standing water, germs develop and are released into the ambient air when switching on the unit again.</p> <ul style="list-style-type: none"> Perform visual inspection of the pump at regular intervals. The level inside the tray and the flow rate have to be checked.

ATTENTION**DAMAGE TO PROPERTY CAUSED BY VIBRATIONS!**

The vibrations caused by the unit make a building vibrate which, in turn, results in collapse of this building or in errors of other systems.

- In order to prevent overload during transport and resulting damage of the vibration dampers, the vibration dampers are supplied loose and can be mounted by the customer.
- Check the fans regularly and replace them if necessary (see section "Fans").

NOTICE

To prevent corrosion caused by stagnant water, units with water as working fluid must be put into operation within two weeks after filling.

6.2 Putting the unit into operation

Requirements

Put the unit into operation only if the following requirements are met:

- A thorough and complete initial cleaning has been performed to remove dirt caused by transport and installation.
- Safe filling is ensured.
- The unit has been properly installed and connected (see section "Installation of the unit").
- A full acceptance test has been performed (see section "Performing an acceptance test").
- The operational readiness has been checked, and the operating point has been set (see below).
- All prescribed safety measures have been taken.

Checking the operational readiness

- ⇒ Ensure that all electrical protective measures are operational.
- ⇒ Ensure that all working fluid-side connections are securely established.
- ⇒ Ensure that all electrical connections (fans) are securely established.
- ⇒ Ensure that the protection guards are attached to the fans.
- ⇒ Ensure that all threaded connections on the fans, the fixing bolts on the unit and all other threaded connections are tight.

Setting the operating point

- ⇒ For the parameters for setting the operating point, refer to the order documents.
- ⇒ Ensure that the specified operating point is maintained. For this, secure the operating elements for setting the operating point against access by unauthorised persons (e.g. by sealing, screwing on caps, removing the handwheels).

Procedure

- ⇒ Switch on the system including the electrical system (see the system's operating instructions).
- ⇒ Switch on the unit.
- ⇒ Open the valves on the inlet and outlet side of the system.

- ⇒ Activate the fans.
- ⇒ Put the drip tray drain line into operation.
- ⇒ Wait until the operating point is reached. Once the operating point is reached, the unit is ready to operate (see the system's operating instructions).
- ⇒ Check units with coolant regularly for correct bleeding after starting the pump.

6.3 Taking the unit out of operation

Introduction

The units are components of a system, including the heat exchanger circuit. The unit is taken out of operation by switching off the system in accordance with the system's operating instructions.

NOTICE

When shutting down the unit, observe the max. operating pressure! When required, take precautions to ensure that it cannot be exceeded.

Procedure

- ⇒ Switch off the fans
- ⇒ Switch off the working fluid feed pump (if any)
- ⇒ Switch off the electrical installation

6.4 Shutting down the unit

Safety

NOTICE

All refrigerants must be removed from the unit by suction and disposed of by an approved specialist company in the field of refrigeration.

Procedure

- ⇒ Shut the unit down (see above).
- ⇒ Secure the unit as follows:
 - Secure the fan motor drives and, in the case of electric defrosting, any heating rods against restart.
 - Secure the working fluid-carrying pipes against supply with working fluid.
 - Protect against damaging effects at the place of installation or intermediate storage location so that the unit's components are kept in good condition and the intended use and usability of the unit are maintained. To this end, appropriate storage conditions (see section "Storing the unit prior to installation") must be provided, precautionary corrosion protection measures must be taken, regular checks of the functionality of the fans must be performed and the shutdown unit must be checked regularly.

- ⇒ With refrigerants (FC/HFC, NH₃, CO₂, and refrigerants of classes A2L to A3) prior to disassembly/removal: Completely remove the working fluid from the unit by suction into a suitable refrigerant container, and completely drain the lubricating oil for refrigerating compressors if necessary.
- ⇒ With coolants prior to disassembly/removal: Completely drain the working fluid from the unit.

If the system is shut down for a period of three weeks or longer, the following must be observed:

- ⇒ Completely disconnect the unit and indicate this accordingly.
- ⇒ Remove dirt and deposits from the outside and inside of the unit.
- ⇒ Store the unit in a place that is not exposed to sunlight. It is recommended to cover the air outlets of the fans to prevent dirt and deposits from entering.

NOTICE

Operate the fans for approx. 2 – 4 hours per month during idle times of one month or longer in order to maintain functionality.

6.5 Putting the unit back into operation after shutdown

Introduction

The unit must be put back into operation in acc. with the system-specific design as set out in the system's operating instructions.

Procedure

- ⇒ Test the unit's readiness for operation.
- ⇒ Perform a pressure test in acc. with EN 378-2 and a visual inspection for corrosion protection.
- ⇒ Put the unit into operation (see section "Putting the unit into operation").

ATTENTION

Water residues in a refrigerating plant operated with refrigerants can result in damage to property!

- Evacuate to ensure that a sufficient degree of dryness of the refrigeration circuit is achieved in acc. with the requirements of EN 378.

6.6 Defrosting

6.6.1 Defrosting functions

Introduction

Recommendations for controlling the defrosting cycle are given below. These recommendations should be adapted to the local conditions in the cold room in order to achieve optimum defrosting behaviour.

If several evaporators or air coolers are installed in a larger cold room, group defrosting can be useful. Here, the units are divided into several groups that are alternately taken out of cool-

ing mode and defrosted. These groups should be arranged in such a way that the units in defrosting cycle and those in cooling mode interfere with each other as little as possible.

Recommended defrost sensor positioning

In order to achieve optimal defrosting (heat exchanger completely free, moisture entry into the cold room minimised), it is crucial to position the defrost sensor carefully. Place it in the fin surface that is visible from the outside (usually the air inlet) where defrosting is finished at the latest time. This is usually also the coldest point in the heat exchanger.

The final defrost temperature should range between approx. 5 and 8 °C.

If the visible fin surface is on the air outlet side of the unit, the final defrost temperature must be set a little higher.

In case the final defrost temperature is set too low, "ice pockets" can build up due to repeated insufficient defrosting.

If the final defrost temperature is set too high, this can cause extreme water vapour formation, which in turn causes the formation of frost and ice around the unit.

NOTICE

The defrost sensor is clamped and fixed directly between two fins. Positioning in an existing contact/supporting tube is not permitted!
Check the position selected during the first defrosting cycles and adjust if necessary.
Check if the defrost sensor measures the correct temperature. With longer connecting cables, it may be required to correct the measured value.

Types of defrosting

The following defrosting types are feasible for the Dual COMPACT:

- Air defrosting
- Electric defrosting

6.6.1.1 Air defrost

Operating principle

With units that are operated at a cold room temperature of at least +4 °C, defrosting by means of circulated room air is sufficient in most cases.

For this, the supply line of the working fluid is interrupted. The "warm" room air in combination with the fan waste heat ensures sufficient defrosting. As inherent to the functional principle, a certain degree of room cooling is thus maintained even during the defrosting process.

The frost accumulation increases the air velocity across the heat exchanger. If the fans installed in the unit allow it, their speed should be reduced during defrosting to such an extent that condensate carry-over in the air flow is prevented.

Start the refrigeration mode again only after complete defrosting as described above.

6.6.1.2 Electric defrost

Operating principle

Defrosting by means of electric heaters is simple, although the efficiency is higher with other methods.



In the heat exchanger, the heaters are placed in tubes named contact tubes in acc. with pre-defined rules. To heat the tray, these heaters are attached to the heating sheet by means of

retaining profiles. The heat generated is transferred to the frost via the fins and the heating sheet respectively.

An on-site monitoring with a safety device (temperature limiter; to be planned for when designing the system) must be provided in acc. with EN 60519-2; VDE 0721; T. 411 (or national relevant standards) to rule out the danger of the units overheating. Operation without temperature monitoring is forbidden. The power supply for electric defrosting must comply with the valid regulations or the EN 60204-1 standard. Refer to the connection diagram for the connection values and recommended fuse rating. In accordance with EN 378-2, electric defrost systems require working fluid displacement or an equivalent suction circuit to prevent the permissible pressure in the unit from being exceeded when using electric defrosting.

6.6.2 Defrosting the unit

Safety

⚠ WARNING	
	<p>RISK OF BURNS! Contact with the heating element during or some time after operation can cause burns (at temperatures above 45 °C).</p> <ul style="list-style-type: none"> • Use heating elements only for their intended purpose. • Wear personal protective equipment (PPE). • If necessary, wait until the temperature has equalised to the ambient temperature before starting to work.
	
⚠ CAUTION	
	<p>RISK OF SLIPPING! During defrosting, condensation water forms that can drip onto the floor and subsequently freeze. There is a risk of slipping.</p> <ul style="list-style-type: none"> • Ensure that the drain of the tray is kept clear.
ATTENTION	
	<p>RISK OF DAMAGE TO PROPERTY! Non-compliance with the defrost instructions can result in cracks and breakage in the pipes and leakage of the working fluid.</p> <ul style="list-style-type: none"> • Perform the defrosting process regularly to remove ice. • Comply with the defrosting requirements. • If necessary, retrofit thermal insulation to the pipes and the connection system. • If necessary, install trace heating on the pipes and the connection system.
NOTICE	
	<p>Observe all safety instructions for operation (see section "Safety instructions for operation").</p>

Defrosting checks

As the local conditions have a very strong influence on the operating behaviour of the unit and the need for defrosting, the heat exchanger must be checked regularly and specifically for frost accumulation and/or icing during operation.

Procedure

- ⇒ If the frost thickness on the fins reaches 1 mm, defrost the unit to ensure proper functioning and reliable operation. The defrosting process can also be started earlier though.
- ⇒ Initiate the defrosting process in good time (see section "Defrost control").
- ⇒ Consider alternating operating states, e.g. changes of use at the place of installation.
- ⇒ Choose the right final defrost temperature.
- ⇒ Consider settling time and delayed fan start.

6.6.3 Factors influencing the defrosting process

Time interval between defrosting cycles

How often defrosting is necessary depends on many influencing factors, e.g.:

- Type of refrigerated goods
- Ambient temperature
- Temperature difference between the working fluid and the room
- Frequency of entering (opening the cold room door)
- Fin spacing

The following factors can require more frequent defrosting:

- Insufficient unit-wall distance
- Too small a distance between opposite units
- Unobstructed air flow disrupted by substructures on a flat cold room ceiling
- Air circulation in the cold room hindered by incorrect goods storage (stacked too high, too close to the wall, crosswise to the air flow direction)
- Final defrost temperature set incorrectly

When the defrosting process is finished, ensure that defrosting has been completed.

6.6.4 Defrost control

General rules

The defrosting process is started at pre-set intervals or in line with demand. The process completion must be verified twice (time/temperature and temperature/temperature).

The defrosting cycle can be divided into four stages:

- Pump-out phase/heating of working fluid
- Defrosting process
- Drip phase
- Freeze-on phase/delayed fan start

Pump-out phase/heating of working fluid:

The supply of the working fluid is interrupted while the "warm" room air flows across the heat exchanger. Any refrigerant still present inside the heat exchanger is evaporated or removed by suction. If a cold brine is used, it is preheated to room temperature.

Defrosting process:

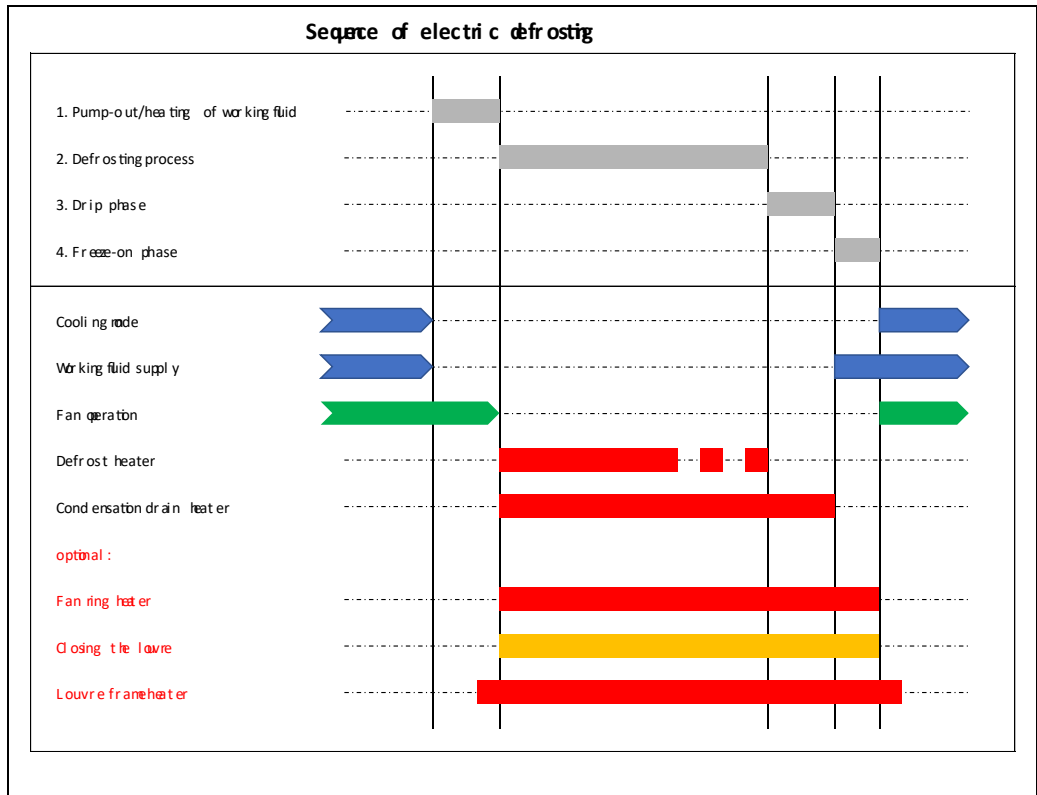

* Exemplary illustration, optional accessories may not be available with the unit.

6.7 Changeover to a different working fluid

Specific hazards

⚠ WARNING	
	<p>RISK OF PERSONAL INJURY AND DAMAGE TO PROPERTY! Operating the unit with a different working fluid without the prior consent of the manufacturer can result in significant dangers (see section "Hazard due to working fluids").</p> <ul style="list-style-type: none">• The unit must not be changed over to a different working fluid without prior written consent from the manufacturer.

Requirements for the working fluid

- Ensure that the unit manufacturer has agreed to the changeover.
- Ensure that the unit is filled with the correct working fluid.
- Ensure that all materials used in the unit are compatible with the new working fluid.
- Ensure that the permissible pressure is not exceeded.
- Check that the new working fluid can be used without requiring a new test certificate for the unit.
- Ensure that classification is complied with.
- Reset the safety device for the unit or replace it where necessary.
- Prevent mixtures with residues of working fluid and possibly oil.
- Change all information regarding the new working fluid accordingly.
- Change the complete documentation including these instructions and the system's operating instructions accordingly.

Procedure

- ⇒ Change the working fluid following written consent by Güntner GmbH & Co. KG and in compliance with the requirements for the working fluid.
- ⇒ Perform an acceptance test (see section "Performing an acceptance test").

6.8 Troubleshooting

Safety instructions

NOTICE
<p>Observe all basic safety instructions and the safety instructions for operating the unit (see sections "Basic safety instructions" and "Safety instructions for operation"). Use suitable tools, protective clothing and safety devices.</p>

Hotline

Phone +49 8141 242-190

E-mail: claims@guentner.com

Troubleshooting table

The following table shows possible faults and the measures to correct them.

Fault	Possible cause(s)	Remedy
Fan motor not running	Power supply interrupted	Restore power supply
	Fan blade stuck	Enable fan to rotate freely
Bearing noises	Defective fan motor	Replace the fan
Unit vibrating	Defective fan blades	Replace fan blades
	Fan bracket loose	Tighten the fixings and replace them if necessary
Unit capacity is not achieved	Coil is very dirty, frosted, iced up on the air side	Clean, defrost the coil
	Fans not running properly or fail to operate	Repair or replace fans
	Working fluid pressurising defective (temperature and quantity insufficient)	Set the working fluid pressurising values (temperature and quantity) according to the design data
	Wrong mixing ratio (with the working fluid water/glycol)	Adjust mixing ratio (concentration, inhibition)
Working fluid escaping	Working fluid-carrying components of the unit are leaking	Switch off the working fluid supply and the fans, document the damage, rectify the leak (see section "Fixing leaks")
Defrosting in the coil very uneven	Malfunions of the coil heating	Check the heating elements and replace them if necessary
Ice build-up/icing in the coil	Unit is not completely defrosted during a defrosting process	Extend defrosting process
Ice build-up/icing in the tray	Malfunions of the tray heating and/or the lower coil heating	Check heating elements and replace them if required

Rectify faults

- ⇒ Close the main lines of the working fluid supply
- ⇒ Wear personal protective equipment (PPE)
- ⇒ Determine and document the size of the leak
- ⇒ If it is required to enter the room with respiratory protection, then
 - activate emergency ventilation,
 - shut off all working fluid supply lines.
- ⇒ Sound the alarm at the slightest suspicion of injured persons in connection with working fluid. First get persons to safety, then eliminate leaks (see section "Fixing leaks"). Close all doors to the room in which the working fluid is escaping.
- ⇒ Press the Emergency STOP switch. This switches off valves, motors and other components to prevent working fluid from escaping.

- ⇒ Close shut-off valves, especially on the liquid side, where possible section by section so that the working fluid volume in the leakage area is kept as low as possible.
- ⇒ If possible, siphon off or drain the system section concerned in a controlled manner, or move the working fluid to other parts of the system. Here too it must be ensured that no liquid working fluid is locked in by shutting off system sections.



7 Maintenance and cleaning

7.1 Safety instructions for maintenance and cleaning



Please note

NOTICE
Observe the basic safety instructions (see section "Basic safety instructions").
NOTICE
Non-compliance with the maintenance schedule can result in cracks and breakage in the pipes and leakage of the working fluid.
NOTICE
The operator is responsible for providing protective clothing for maintenance and cleaning.
NOTICE
The operator is responsible for selecting suitable cleaning agents, antifreeze agents und corrosion inhibitors, and for observing and complying with the manufacturers' instructions.

Specific hazards





⚠ DANGER	
	<p>ELECTRICAL VOLTAGE! Cleaning using a jet of water or steam causes water to enter live components. This results in a short circuit at the electrical connections and/or a life-threatening electric shock. This, in turn, can cause severe injury or even death of bystanders.</p> <ul style="list-style-type: none"> • Completely disconnect the supply line before performing electrical work on the unit. • Do not point the water jet at live components (e.g. terminal box). • Do not use steam cleaners or high-pressure cleaners on live components. • Ensure that live components are not hit by water or vapour jets (cover if necessary). • Observe the cleaning pressures and distances when cleaning. • Work on the unit and the connection and control configuration must be performed by specialist staff. • Check electrical components regularly. • Perform earthing checks and visual inspections of the earthing points regularly. • Connect the unit to the building's earthing system in the proper manner. • The condensate pump has an IP5 rating. It must be protected from moisture and removed for cleaning work.
	

⚠ WARNING





RISK DUE TO FALLING OR EJECTED OBJECTS!
Parts, dirt and masses of water or ice can fall down when hinging the tray down and injure bystanders.

- Keep the tray's drain clear at all times.
- Completely disconnect the unit and secure it against unintentional restart before opening the tray.
- Do not stand under the tray.
- Wear personal protective equipment (PPE).







⚠ WARNING



RISK OF CRUSHING!
When working in the vicinity of moving components such as the hinged tray, limbs can get caught between the components and be crushed.

- Completely disconnect the unit before performing maintenance work, including opening the tray.
- Secure the unit against unintentional restart. A lockable repair switch is available or to be provided by customer. Attach an appropriate warning label to the unit.
- Wear personal protective equipment (PPE).







⚠ WARNING



RISK OF SLIPPING!
Unit is cleaned using water at sub-zero temperatures. The water collects on the floor and ice builds up under the unit. Person slips and falls.

- Operation and cleaning only by specialist staff.
- The cleaning agents and methods must be adapted to the ambient temperatures.
- Wear safety shoes.



⚠ CAUTION		
	<p>RISK OF DAMAGE TO THE EYES! During cleaning work, there is a risk of injury from the water or air jet, dust or chemical cleaning agents.</p> <ul style="list-style-type: none"> • Wear safety goggles! 	

7.2 Procedure prior to all maintenance work

Before performing any maintenance work, carry out the following safety measures:

- ⇒ Completely disconnect the unit and secure it against accidental switching on.
- ⇒ Drain or siphon off the coil (heat exchanger) of the unit.
- ⇒ Completely remove the working fluid from the leaky unit, especially prior to soldering and welding work.
- ⇒ Clean and blow out the coil (heat exchanger) of the unit.

7.3 Inspection/maintenance schedule

7.3.1 Unit

Measure	Means	Interval
Remove frost and perform partial cleaning	Mechanical	As required (visual inspection)
Perform complete cleaning	Warm water or environmentally safe cleaning agent that is compatible with the unit's materials	As required (visual inspection)
Testing in acc. with PED as prescribed by the accredited inspection bodies		Every 12 months
Inspection of the system (leak tightness tests, among other things) in acc. with DIN EN 378-4		Every 12 months
Check for leaks		Every 6 months
Check corrosion protection		Every 6 months
Check earthing concept		Every 6 months (visual inspection) Every 12 months (measurement)

Measure	Means	Interval
Check that electrical connections, cables and components are not damaged (visual inspection)		Every 6 months
Check fastenings: Check all fasteners of the unit including any optional additions	Mechanical	Every 6 months
Check fixings and load-bearing elements (e.g. crane lug bolts) for corrosion and load-bearing capacity or structural integrity; replace them if necessary	Mechanical	Every 12 months
Check units with water/glycol working fluid for correct bleeding. Note: During the test, the pump must be running.		Every 6 months
For terminal boxes, check cable entries and their seals for damage and replace if necessary.		Every 6 months

7.3.2 Heat exchanger coil

External inspection

Have a competent person (recommendation: Güntner GmbH & Co. KG) perform a regular external check (visual inspection) on the unit every 5 years.

Maintenance schedule

d = daily, w = weekly, m = monthly, y = yearly				
Work to be performed	d	w	m	y
Check the coil, tray and connection compartments for dirt, frost and ice accumulation. <ul style="list-style-type: none"> In the event of dirt accumulation: Clean the coil, tray and connection compartments (see section "Cleaning the coil"). In the event of frost and ice accumulation: Defrost the coil, tray and connection system (see section "Defrosting the unit"). 	X			
Check return bends of the coil side as well as all connections and pipes inside the casing for icing. <ul style="list-style-type: none"> In case of icing: Defrost the unit (see section "Defrosting the unit"). 				X*
Check the coil's general condition. <ul style="list-style-type: none"> If damage is found: Rectify damage. 		X		
Check the coil's operating point (see section "Installation and commissioning").			X	

d = daily, w = weekly, m = monthly, y = yearly				
Work to be performed	d	w	m	y
<ul style="list-style-type: none"> If change in fan capacity is found: Restore required system-side conditions. If change in surface temperatures is found: Restore required system-side conditions. 				
Check the coil and connections for leak tightness. <ul style="list-style-type: none"> Repair unit sections affected (see section "Fixing leaks") 				X*
Check the working fluid pressurising of the coil. <ul style="list-style-type: none"> Restore required system-side conditions. 				X*
Check the coil for corrosion. <ul style="list-style-type: none"> Corrosion or damage on core tubes, fins, support structures, pipe connections, fastenings: Repair unit sections affected. 				X*

*) Recommended: every six months

7.3.3 Fans

Maintenance schedule

d = daily, w = weekly, m = monthly, y = yearly																
Work to be performed	d	w	m	y												
Check fans for dirt, frost and ice accumulation <ul style="list-style-type: none"> In the event of dirt accumulation: Clean the fans (see section "Cleaning the fans") In the event of frost and ice accumulation: Defrost the unit (see section "Defrosting the unit") 	X															
Check the fan drive for quiet running <ul style="list-style-type: none"> Vibrations on the unit: Eliminate imbalances When required, tighten blade fixing devices and correct blade settings 		X														
Check fan bearings (every six months by manually turning the rotor while the fan is switched off) <ul style="list-style-type: none"> Running noise and smoothness of running changes: Replace the fan 			X													
Impeller: Corrosion on bolts (with threaded blades) <ul style="list-style-type: none"> Replace screws 				X*												
Fan blades: Corrosion or damage on blades <ul style="list-style-type: none"> Replace the fan 				X*												
EC fan terminal boxes: Check threaded connections <ul style="list-style-type: none"> Retighten alle threaded connections in acc. with the following table <table border="1" data-bbox="427 1787 1177 1980"> <thead> <tr> <th>Manufacturer</th> <th>Plastic cover</th> <th>Metal cover</th> </tr> </thead> <tbody> <tr> <td>ebm</td> <td>1.5 Nm</td> <td>3.5 Nm</td> </tr> <tr> <td>Ziehl-Abegg</td> <td>1.3 Nm</td> <td>2.6 Nm</td> </tr> <tr> <td>Hidria</td> <td>2 Nm</td> <td>-</td> </tr> </tbody> </table>	Manufacturer	Plastic cover	Metal cover	ebm	1.5 Nm	3.5 Nm	Ziehl-Abegg	1.3 Nm	2.6 Nm	Hidria	2 Nm	-				X*
Manufacturer	Plastic cover	Metal cover														
ebm	1.5 Nm	3.5 Nm														
Ziehl-Abegg	1.3 Nm	2.6 Nm														
Hidria	2 Nm	-														

*) Recommended: every six months

7.4 Maintenance work

7.4.1 Fixing leaks

Procedure

- ⇒ Report any leaks on the unit to Güntner and have them fixed as quickly as possible by a competent person.
- ⇒ Perform all work including pressure, acceptance and functional test (see section "Performing an acceptance test").

7.4.2 Cleaning the unit

Introduction

For easier cleaning, some parts of the unit (e.g. tray, side cover and protection guard) are hinged or removable (see section "Remove/hinge down the tray and side cover").

The following applies for cleaning: The operator must ensure that the cleaning agent is environmentally friendly. Substances that are harmful to the environment, e.g. acid-forming substances, are forbidden.

Cleaning in areas with stringent hygiene requirements

NOTICE

When using cleaning agents, ensure they are carefully rinsed off with clear water to prevent corrosion.
Perform cleaning regularly and when required. Basically, these intervals should correspond with the cycles specified in the respective area with stringent hygiene requirements.

Procedure

- ⇒ Ensure that the unit is free of voltage.
- ⇒ Remove accessories (if any).
- ⇒ Perform cleaning tasks in acc. with the indications on the drawings (see section "Hydraulic cleaning"). Make sure to maintain the required distance and angle. An upward inclination is not permissible to protect the fan from water ingress.
- ⇒ Clean the casing by rinsing with warm water (approx. +20 °C recommended) and/or with environmentally friendly cleaning agents.
- ⇒ Rinse the casing thoroughly with warm water after using cleaning agents. The unit must be free of cleaning agents to prevent corrosion.
- ⇒ Allow the casing to dry completely.
- ⇒ Fix the hinged or removable tray and the easy-to-open side covers in their original positions and secure them against unintentional or unauthorised opening.
- ⇒ Check the working fluid-side and electrical connections.
- ⇒ Clean the inside of the tray regularly.

7.4.3 Remove/hinge down the tray and side cover

Introduction

For cleaning and maintenance, the tray and the side cover can be hinged down or removed. The tray is provided with a tray securing device which has to be removed for this purpose.

Overview

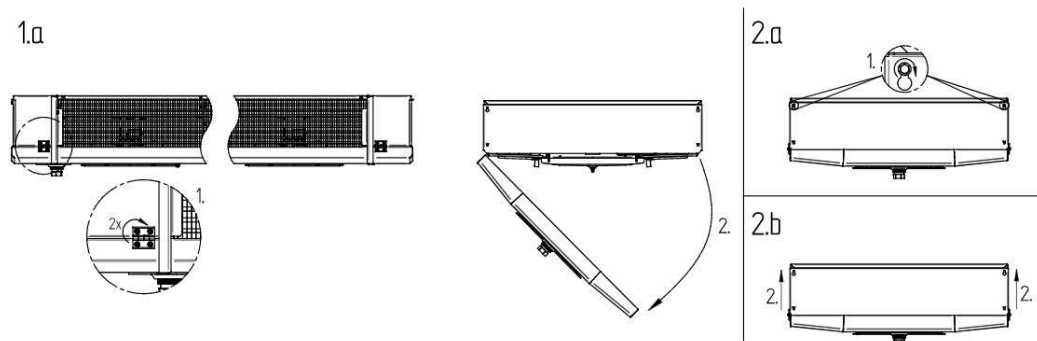

Hinge the tray down (1.a)

- ⇒ Loosen and remove the top two bolts on the hinge (1)
- ⇒ Hinge the tray down (2)

Open the side panel (2.a)

- ⇒ Loosen and remove the bolts (1)

Unhinge the side panel (2.b)

- ⇒ Pull the side panel upwards and remove it (2)

7.4.4 Cleaning the coil

Introduction

Removing the fans (see section "Dismantling and disposal") creates space with a few simple turns for better cleaning of the heat exchanger coil. The cleaning method depends on the type and degree of soiling and the place of installation. With loose and dry dirt, cleaning with compressed air is sufficient. With solid, damp and greasy dirt, we recommend hydraulic cleaning.

Specific hazards

⚠ CAUTION



RISK OF DAMAGE TO PROPERTY!

If the pressure is too high, the distance is too small or the cleaning jet hits the fins at an angle, the fins can be damaged. Mechanical cleaning with hard objects (e.g. steel brushes, screwdrivers, etc.) will damage the heat exchanger.

- Use a pressure of max. 30 bar for hydraulic cleaning and max. 8 bar for cleaning with compressed air!
- Keep a minimum distance of 200 mm from the fins!
- Always direct the jet at right angles to the fins (max. deviation of ±5 degrees) to prevent the fins from bending!
- Do not use hard objects for cleaning!

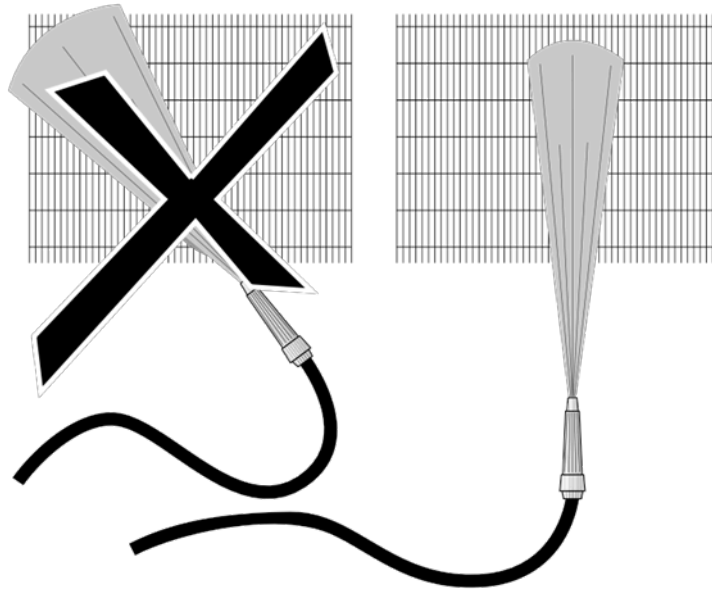

Preparation for cleaning

- ⇒ Perform defrosting process
- ⇒ Prepare and shut off the unit in acc. with the system's operating instructions
- ⇒ Clean the coil (heat exchanger) with one of the following procedures:
 - Cleaning with compressed air (see section "Cleaning with compressed air")
 - Hydraulic cleaning (see section "Hydraulic cleaning")
 - Cleaning with brush or brush and compressed air (see section "Cleaning with brush or brush and compressed air")

7.4.4.1 Cleaning with compressed air

Procedure

- ⇒ Blast the coil with compressed air (max. 80 bar pressure, distance to the fins at least 200 mm; against the air flow direction) to remove dirt and impurities. Please note:
 - Preferably clean from inside to outside and from top to bottom to prevent loosened dirt from settling on areas that have already been cleaned.
- ⇒ Clean until all dirt has been removed.

7.4.4.2 Hydraulic cleaning

Procedure

- ⇒ Always remove heavier damp or greasy dirt against the air flow direction, using a high-pressure water jet (max. 30 bar pressure) or a steam pressure jet (max. 30 bar pressure). In either case, use a flat spray nozzle (distance of at least 200 mm) and, if required, neutral cleaning agents. Always direct the jet at right angles to the fins (max. deviation of ± 5 degrees). Please note:
 - With oily and greasy deposits, add a cleaning agent to the water.
 - When applying cleaning agents, change them from time to time to prevent resistance development in germs.

- When using chemical cleaning agents, ensure that they do not attack the surfaces of the unit. After cleaning, the unit must be rinsed with warm water so that it is free of cleaning agents.
 - Clean against the air flow direction and from top to bottom (Güntner recommendation) so that dirt is not pushed even deeper into the heat exchanger or does not move to already cleaned areas.
- ⇒ Clean until all dirt has been removed.

7.4.4.3 Cleaning with brush or brush and compressed air

Procedure

- ⇒ Remove dry dust or dirt with a brush, a hand brush and – depending on the situation – compressed air (max. 8 bar pressure, minimum distance of 200 mm to the fins; against the air flow direction) or with a powerful industrial vacuum cleaner. Please note:
 - Use soft brushes (no steel brushes or similar).
 - Preferably clean from inside to outside and from top to bottom to prevent loosened dirt from settling on areas that have already been cleaned.
- ⇒ Clean until all dirt has been removed.
- ⇒ Always brush in the longitudinal direction of the fins, never across.

7.4.5 Cleaning the fans

Procedure

- ⇒ Completely disconnect the unit and secure it against accidental switching on.
- ⇒ Remove protection guard and accessories (if any).
- ⇒ Clean the fans in acc. with one of the following procedures:
 - Cleaning with compressed air: Blow the fans with compressed air (pressure max. 10 bar, distance to the fins at least 200 mm) to remove dirt and impurities. Clean until all dirt has been removed.
 - Cleaning with brush and compressed air: Remove dry dust or dirt with a brush or a hand brush, and then with compressed air (pressure max. 10 bar, distance to the fins at least 200 mm) or a powerful industrial vacuum cleaner. Clean until all dirt has been removed.
- ⇒ Switch on the unit.

7.5 Procedure after all maintenance work

After completing all maintenance work, carry out the following safety measures:

- ⇒ Ensure that the switching and activation devices, the measuring and display devices and the safety devices function properly.
- ⇒ Ensure that the working fluid fittings function properly.
- ⇒ Check the labelling of the pipes and ensure that the labels/tags are visible and legible.
- ⇒ Check the fastening and the corrosion protection of the components concerned.
- ⇒ Ensure that the electrical connections (e.g. fans and, where applicable, heating rods for electric defrosting) function properly.
- ⇒ Perform a pressure test in acc. with EN 378-2 and a leak test (see operating instructions of the plant).
- ⇒ Perform an acceptance test (see section "Performing an acceptance test").

- ⇒ Perform a functional test (see the system's operating instructions).
- ⇒ Document all tests performed and their results.

8 Dismantling and disposal

8.1 Safety instructions on dismantling and disposal

Please note

NOTICE

Observe all basic safety instructions (see section "Basic safety instructions"), all safety instructions for transport (see section "Safety instructions for transport and unpacking"), all safety instructions for installation (see section "Safety instructions for installation and commissioning") and all safety instructions for maintenance (see section "Safety instructions for maintenance and cleaning")!

Specific hazards

⚠ CAUTION



RISK OF INJURY CAUSED BY CORROSION!

The unit is exposed to corrosive environment for a long time. Due to the onset of corrosion, the unit loses stability and is no longer suitable for lifting by crane or industrial truck with forks and endangers bystanders.

- Defrost the unit properly and keep it free of ice.
- Check the fan unit in acc. with the maintenance schedule.
- Check all fixing bolts and fixing devices, load-bearing components, lifting elements, fixing elements and fans of the unit regularly and especially before and after lifting the unit for corrosion damage, lifting capacity and structural integrity, and replace them if necessary. In case of doubt, hire a specialised company.
- Prior to dismantling and disposal of the unit, ensure that there are no loose or slack parts on the unit.

ATTENTION

RISK OF ENVIRONMENTAL DAMAGE!

Recovering or disposing of working fluid can result in working fluid or refrigerator oil emissions being released into the environment, causing pollution.

- All working fluids must be removed from the unit by suction and disposed of by an approved specialist company in the field of refrigeration.
- Ensure that no working fluid enters the groundwater.
- Operate the facility for recovering or disposing of working fluids in such a way that the risk of working fluids being released into the environment is kept as low as possible.
- Ensure that all applicable standards and guidelines are complied with.
- Observe local regulations.

ATTENTION

RISK OF POLLUTION!

If the materials are not disposed of correctly, this could result in environmental damage.

- Only dispose of materials in compliance with the waste disposal laws that are binding for the country of operation.

8.2 Dismantling the unit

Required staff

- Dismantling must be performed by at least two people (specialist staff).

Auxiliary equipment/tools

- Lifting accessories and lifting gear
- Climbing aids

Procedure

- ⇒ Completely disconnect all systems.
- ⇒ Shut down and drain the unit (see section "Shutting down the unit").
- ⇒ Make sure that there are no loose parts on the unit.
- ⇒ Follow the removal sequence:
 - Remove the accessories for defrosting (if any)
 - Remove the protection guard (if any)
 - Remove the fan(s)
 - Remove the tray
- ⇒ Follow the installation steps in reverse order (siehe Abschnitt "Installation of the unit").

8.3 Disposing of the unit

Introduction

At the end of its life cycle, the unit requires proper and professional disposal of the materials and substances used.

Procedure

- ⇒ Disposal must be performed by competent persons.
- ⇒ All unit components, e.g. working fluids, lubricating oil for refrigerating compressors, coil (heat exchanger), fans and optional accessories must be disposed of properly.
- ⇒ Treat used working fluid that is not intended for reuse as waste and dispose of it safely. There must be no emissions into the environment.
- ⇒ Do not use a disposable single-use container as working fluid vapour residues in the container could escape during disposal.
- ⇒ Do not overfill the working fluid container. The maximum permissible pressure of the working fluid container must not be exceeded during the entire work process.
- ⇒ Do not pour the working fluid into a fluid container that contains a different or an unknown working fluid. Do not release this other or unknown working fluid into the atmosphere but rather identify it, reclaim it or properly dispose of as specified.
- ⇒ Instruct an officially authorised facility to destroy the working fluid.
- ⇒ With evaporators: Keep used lubricating oil for refrigerating compressors that has been recovered from the unit and cannot be reclaimed in a separate, suitable container, treat it as waste and dispose of it safely.
- ⇒ All applicable laws, regulations, directives and standards must be complied with when disposing of materials and substances.

9 Accessories



9.1 Condensate pump

Introduction

The pre-installed condensate pump is used to remove the condensation water from the tray by suction.

- The condensate pump is permissible only in units with a fluid temperature greater than 2 °C.
- Retrofitting of a pump is not permitted if this has not been approved by the manufacturer.
- Improper use of the condensate pump can result in malfunctioning of the unit.

Safety

 DANGER		
	<p>ELECTRIC SHOCK! A person receives an electric shock through contact with the connecting cable. The casing of the pump is made of plastic.</p> <ul style="list-style-type: none">• Disconnect the supply line from the mains before performing electrical work on the unit.• The connection of the unit and the control configuration must be performed by specialist staff.• Check electrical components regularly.• Perform visual inspections of the earthing points regularly.• Perform earthing checks regularly.• Connect the unit to the building's earthing system in the proper manner.• All work must be performed by specialist staff.• Observe the five safety rules of the German standard series DIN VDE 0105-100 ("Die fünf Sicherheitsregeln für Arbeiten im spannungsfreien Zustand") or national relevant regulations to prevent electrical accidents.• Provide adequate lightning protection.	

Overview

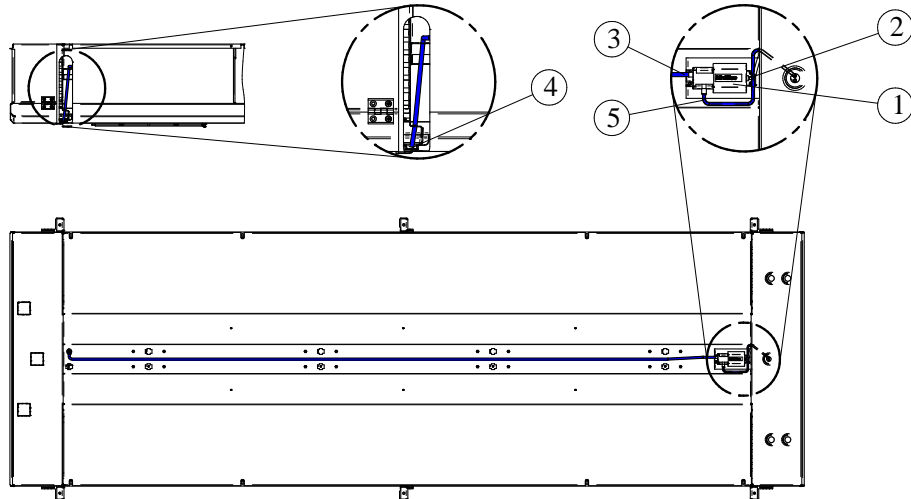

- 1 Condensate pump
- 2 Electrical connection
- 3 Suction side, attached hose
- 4 Area where condensate is being sucked in
- 5 Hose to be attached by the customer

Dimensions:

- Max. discharge head: 4 m
- Hose length: 2 m
- Hose diameter: 8 mm